

Talenti

OUTDOOR LIVING

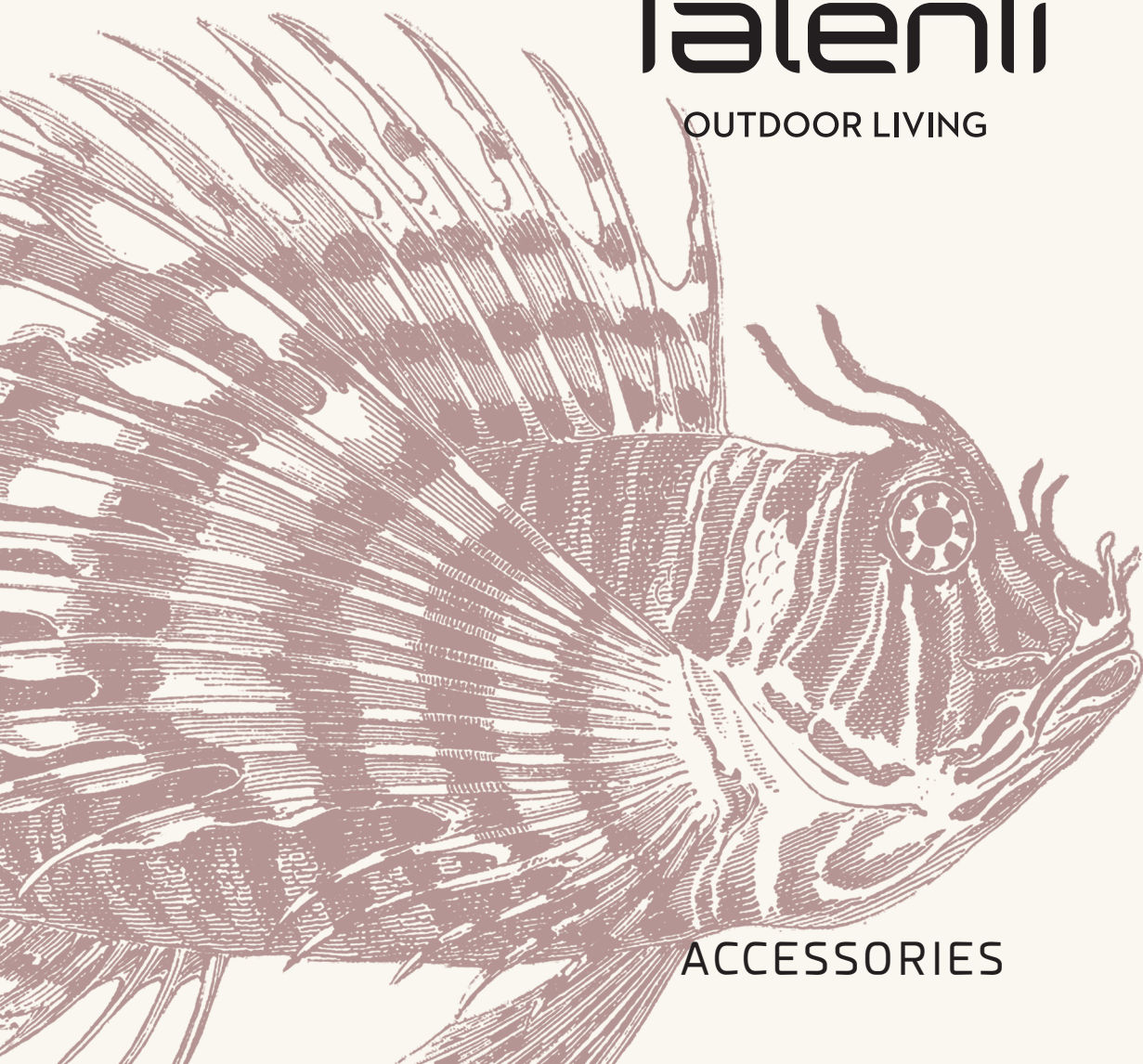

ACCESSORIES

Talenti®
OUTDOOR LIVING

ACCESSORIES

INDEX

Skyline	05	Cleo//lamps	155
Mr X	19	Tod//lamps	167
Zeus	29	Kukà//lamps	173
Athena	37	Malè//lamps	187
Venere	47	Coral//lamps	197
Marte	53	Tofee//lamps	205
Vulcano	63	Scacco	211
Apollo	69	Tikal	219
Jackie	75	Showergate	229
Carpets	105	Path	235
Gabri	123	Cart	243
Plaza	129	Ray	251
Casilda//lamps	137	Box	257
Tribal//lamps	143		



Skylinecollection
Design Ludovica + Roberto Palomba









Skylinecollection

Design Ludovica + Roberto Palomba

Finishing

Aluminium frame



canopy



- 1-Il telo è una membrana composita micro-forata. Peso 360 g/m² e spessore di 0,45mm.
- 2-Un lembo del telo è provvisto di un occhiello per inserire il tubolare di alluminio. L'altro lembo è provvisto di una speciale cucitura che si inserisce nella sede di un profilo ad-hoc di alluminio.
- 3-Il tensionamento dei teli avviene ruotando il profilo ad-hoc sul proprio asse. La ruota dentata inserita negli snodi garantisce tenuta e regolazione.
- 4-Una volta srotolato, il telo si può rimuovere sfilandolo dalla sua sede attraverso un'asola nello snodo.

- 1-The fabric is a micro-perforated composite membrane. Weight 360 g/m² and thickness of 0.45mm.
- 2-One edge of the sheet is provided with an eyelet to insert the aluminum tubing. The other flap is provided with a special stitching that fits into the seat of an ad-hoc profile of aluminium.
- 3-The tensioning of the sheets occurs by rotating the ad-hoc profile on its axis. The cogwheel inserted into the joints it guarantees tightness and adjustment.
- 4-Once unrolled, the sheet can be removed by sliding it out of its seat through a slot in the joint.

Specifiche:
Struttura in alluminio.
Telo PES + PVC coating.

In caso di condizioni avverse liberare il telo per evitare danni alla struttura, a cose e persone.

Technical specifications:
Aluminium structure.
Canopy PES + PVC coating.

In case of bad weather conditions, we strongly recommend to close the parasol in order to avoid damages to the structure, to objects and persons.

MODULE A 280X190 H240 / CODE: SKYMODA

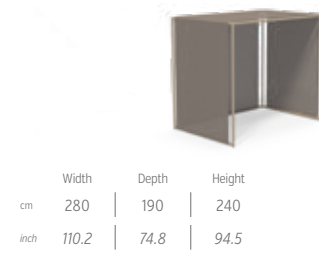

MODULE A1 280X190 H310 / CODE: SKYMODA1

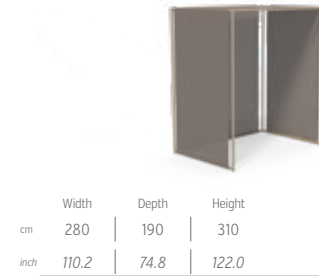

MODULE B 280X280 H240 / CODE: SKYMODB

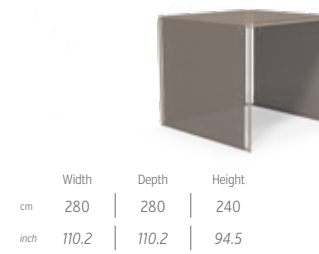

MODULE B1 280X280 H310 / CODE: SKYMODB1

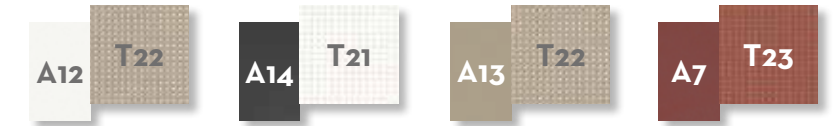

MODULE C 380X190 H240 / CODE: SKYMODC

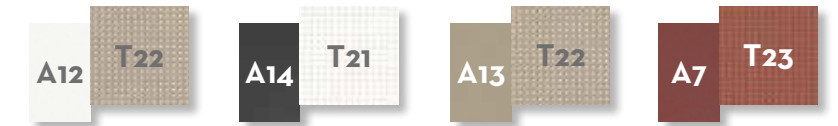

MODULE C1 380X190 H310 / CODE: SKYMODC1



MODULE D 380X280 H240 / CODE: SKYMODD



	Width	Depth	Height
cm	380	280	240
inch	149.6	110.2	94.5

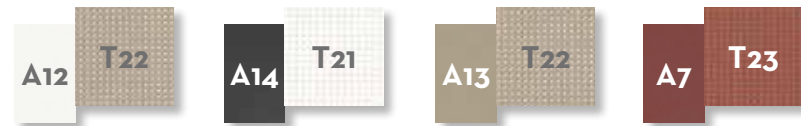

MODULE D1 380X280 H310 / CODE: SKYMODD1



	Width	Depth	Height
cm	380	280	310
inch	149.6	110.2	122.0

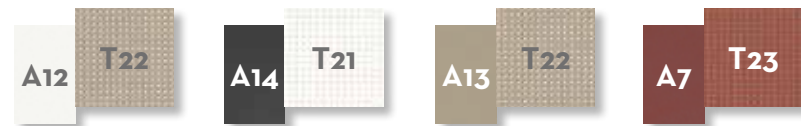

PARTITION H240 / CODE: SKYMODPAR



	Width	Depth	Height
cm	556	280	240
inch	218.9	110.2	94.5



COMPOSITION 1 - 465x280 H240/310 / CODE: SKYCOM1
MODULI / MODULS: A+B1



COMPOSITION 6 - 375x465 H240/310 / CODE: SKYCOM6
MODULI / MODULS: C1+D



COMPOSITION 2 - 550x280 H240/310 / CODE: SKYCOM2
MODULI / MODULS: B+B1



COMPOSITION 7 - 375x550 H240/310 / CODE: SKYCOM7
MODULI / MODULS: D1+D



COMPOSITION 3 - 650x280 H240/310 / CODE: SKYCOM3
MODULI / MODULS: A+A+B1



COMPOSITION 8 - 650x375 H240/310 / CODE: SKYCOM8 (photo pag. 8-9)
MODULI / MODULS: C1+C1+D



COMPOSITION 4 - 740x280 H240/310 / CODE: SKYCOM4
MODULI / MODULS: B1+A+B1



COMPOSITION 9 - 650x375 H240/310 / CODE: SKYCOM9 (photo pag. 10-11)
MODULI / MODULS: D1+C+C



COMPOSITION 5 - 740x465 H240/310 / CODE: SKYCOM5
MODULI / MODULS: A+B1+A+B1+A



COMPOSITION 10 - 925x560/650 H240/310 / CODE: SKYCOM10 (photo pag. 6-7)
MODULI / MODULS: D+C+C+D+A1+A1+A1

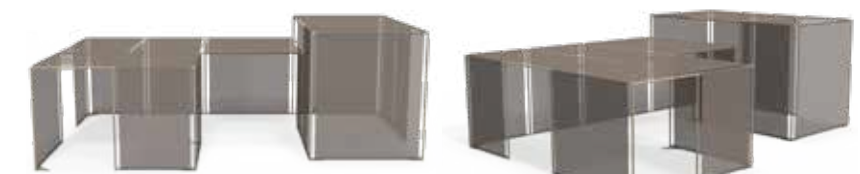



MrXcollection
Design Marco Acerbis



MrXcollection

sun sail
graphite colour

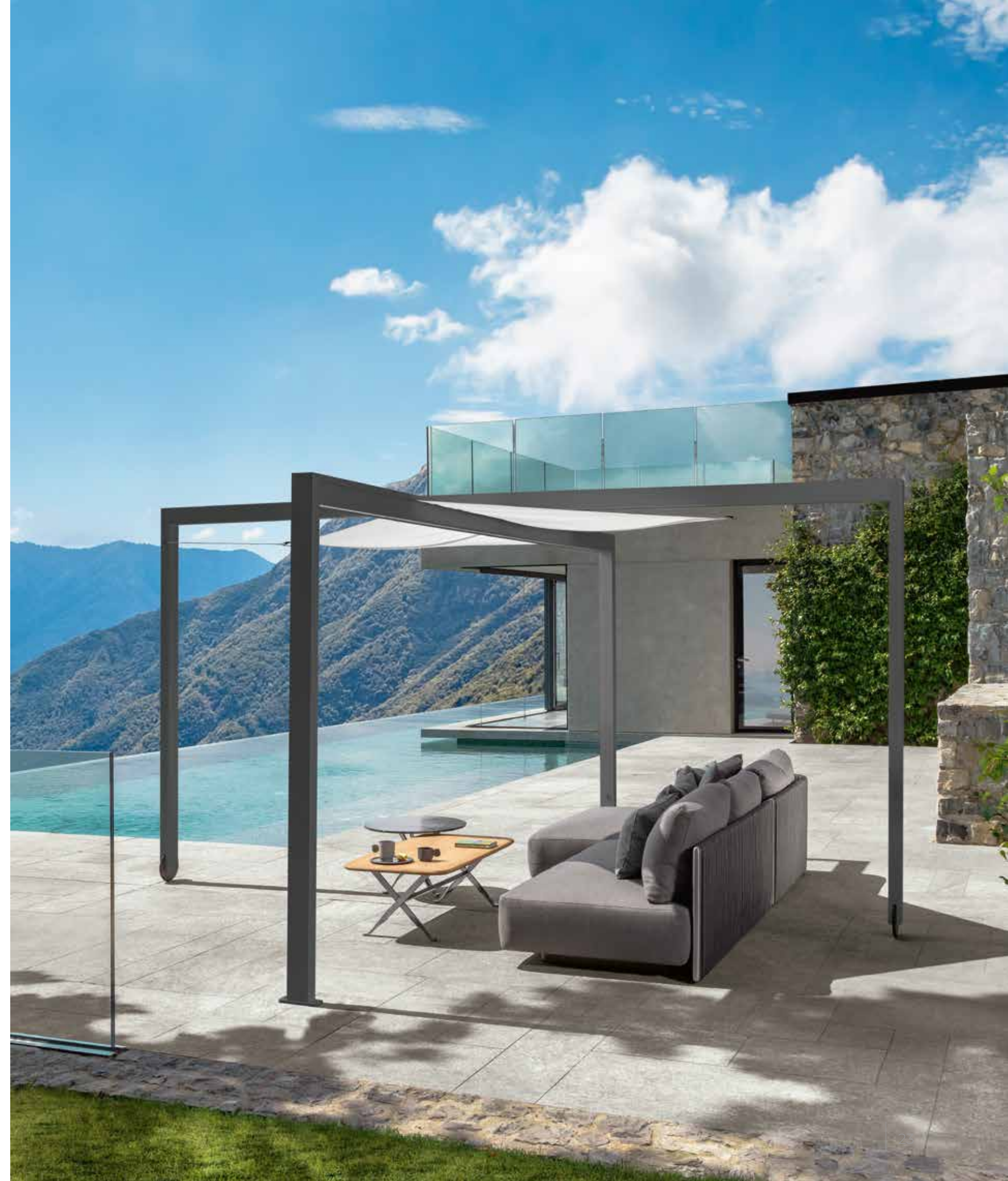



MrXcollection

Design Marco Acerbis

MRX / CODE: MRX01



	Width	Depth	Height
cm	380	280	240
inch	149.6	110.2	94.5



Finishing

Aluminium frame



white



grahite

canopy



white

SISTEMA DI APERTURA / OPENING SYSTEM

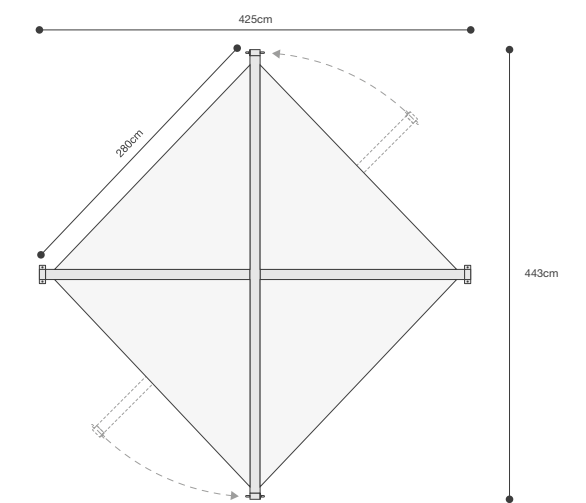
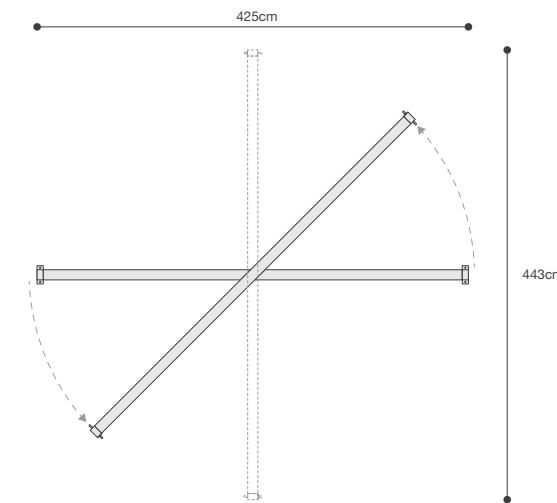

- 1 - Copertura massima vela 2,8x2,8 m.
- 2 - Illuminazione led da 20W con profilo su trave superiore, alimentazione a batteria ricaricabile estraibile, accensione con telecomando.
- 3 - Alla base dei due pali la struttura è provvista di piastre per l'ancoraggio al suolo tramite tasselli.
- 4 - Apertura con sistema a compasso.
- 5 - Due pali con ruota alla base per facilitare l'apertura della struttura.
- 6 - Sistema di apertura/chiusura vele tramite avvolgitore manuale.
- 7 - Telo 100% PET Tinto Massa idrorepellente da 220 gr/mq

- 1 - Maximum coverage of the canopy 2.8x2.8 m.
- 2 - 20W led lighting with profile on upper beam, power supply with removable rechargeable battery, ignition with remote control.
- 3 - At the base of the two poles, the structure is supplied with plates designed for the floor fastening through anchoring dowels.
- 4 - Compass opening system.
- 5 - To facilitate the opening system, the structure is equipped with two rotating poles provided with wheels.
- 6 - Sail opening and closing system with manual crank.
- 7 - Canopy 100% PET Solution Dyed FR water-repellent 220 gr/mq

Specifiche:
 Peso della struttura 60kg
 Pali in alluminio con profilo 100x60 mm
 Altezza della struttura 230cm
 In caso di condizioni avverse avvolgere le vele per evitare danni alla struttura, cose e persone.

Technical specifications:
 Structure weight 60kg
 Aluminium Pole 100x60 mm
 Height of the structure 230cm
 In case of bad weather conditions, we strongly recommend to roll up the sails in order to avoid damages to the structure, to objects and persons.



Parasolcollection
// Zeus



Parasolcollection
// Zeus

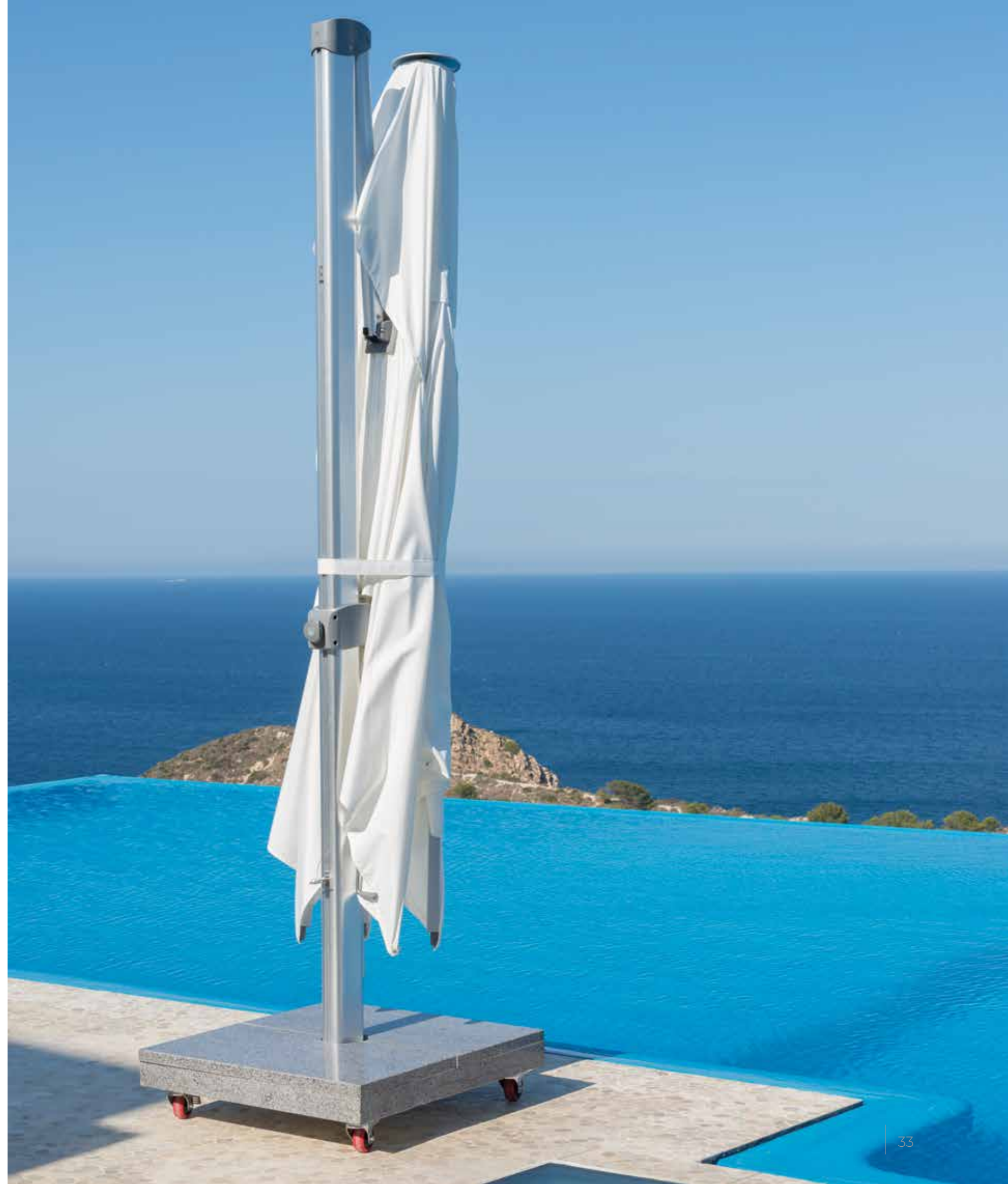

Parasolcollection

// Zeus

Finishing

Aluminium frame

Waterproof fabric canopy



anodized

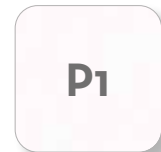

white

Features

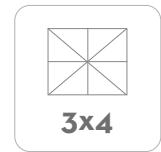
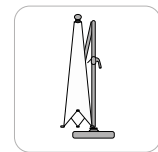

- 1-Telo 3x4 o 4x4 in tessuto da 250g in poliestere trattato in PU.
- 2-Optional: illuminazione a batteria ricaricabile.
- 3-Sistema di apertura retrattile che permette la chiusura parallela al palo. Apposite guide di scorrimento ne facilitano lo spostamento.
- 4-Sistema di apertura e chiusura del telo tramite manovella manuale removibile. Il palo girevole permette all'ombrellone di ruotare di 360°.
- Basamento in granito (180kg) con ruote.
- 5-Optional: illuminazione con impianto audio per collegamento dispositivi bluetooth.

- 1-Canopy 3x4 or 4x4 in 250g polyester with PU coating.
- 2-Optional: umbrella lights with rechargeable battery.
- 3-Retractable opening system allows umbrella closure parallel to the pole. Sliding guides make movements easier.
- 4-Canopy opening/closure with removable hand crank.
- Turning pole allows parasol a 360° rotation. Granite base (180kg) with wheels.
- 5-Optional: umbrella bluetooth speaker with led lights.

Specifiche:
 Palo in alluminio 120x76 mm
 7 Stecche in alluminio 20x35 mm
 Telo UV80+
 Altezza ombrellone 300 cm
 Basamento granito 180 kg 80x80x10 cm
 In caso di condizioni avverse chiudere l'ombrellone per evitare danni alla struttura, a cose e persone.

Technical specifications:
 Aluminium Pole 120x76 mm
 No.7 alu ribs 20x35 mm
 UV80+ Canopy
 Parasol height 300 cm
 Granite base 180 Kg 80x80x10 cm
 In case of bad weather conditions, we strongly recommend to close the parasol in order to avoid damages to the structure, to objects and persons.

ZEUS 3x4 / CODE: PARZES-A

KG 228,0

unit 1+1+1+1
0.53 mc



•80x80•

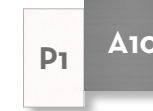

ZEUS 4x4 / CODE: PARZES2-A

KG 240,0

unit 1+1+1+1
0.53 mc



•80x80•





Parasolcollection
// Athena







Parasolcollection

// Athena

ATHENA 3x4 / CODE: PARATH



Finishing

Aluminium frame



Waterproof fabric canopy



Features

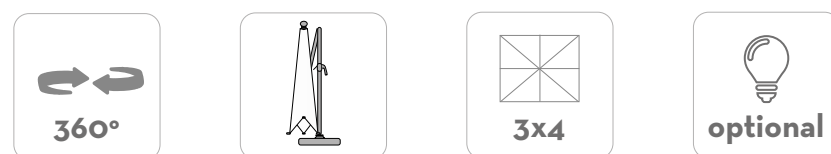

- 1-Telo 3x4 in tessuto da 250g in poliestere trattato in PU.
- 2-Optional: illuminazione a batteria ricaricabile.
- 3-Sistema di apertura retrattile che permette la chiusura parallela al palo.
- Apposite guide di scorrimento ne facilitano lo spostamento.
- 4-Sistema di apertura e chiusura del telo tramite manovella manuale removibile.
- Il palo girevole permette all'ombrellone di ruotare di 360°.
- 5-Optional: illuminazione con impianto audio per collegamento dispositivi Bluetooth.
- 6-Basamento in acciaio di colore bianco o tortora. Per una stabilità ottimale si consiglia l'utilizzo di n.10 piastre in graniglia 50x50x3,5cm (pesi non inclusi).

- 1-Canopy 3x4 in 250g polyester with PU coating.
- 2-Optional: umbrella lights with rechargeable battery.
- 3-Retractable opening system allows umbrella closure parallel to the pole.
- Sliding guides make movements easier.
- 4-Canopy opening/closure with removable hand crank.
- Turning pole allows parasol a 360° rotation.
- 5-Optional: umbrella Bluetooth speaker with led lights.
- 6-Steel base in white or dove colour. For a better stability we recommend you to use 10 grit plates 50x50x3,5cm (weights not included).

- Specifiche:
- Palo in alluminio 120x76 mm
 - 7 Stecche in alluminio 20x35 mm
 - Altezza ombrellone 310 cm
 - Telo UV80+
 - Basamento in acciaio 55x133x20 cm (Pesi non inclusi)
 - In caso di condizioni avverse chiudere l'ombrellone per evitare danni alla struttura, a cose e persone.

- Technical specifications:
- Aluminium Pole 120x76 mm
 - No.7 alu ribs 20x35 mm
 - Parasol height 310 cm
 - UV80+ Canopy
 - Steel base 55x133x20 cm (weights not included)
 - In case of bad weather conditions, we strongly recommend to close the parasol in order to avoid damages to the structure, to objects and persons.





Parasolcollection
// Venere



Parasolcollection

//Venere

VENERE 3x3 / CODE: PARVEN



Finishing

Aluminium frame



anodized

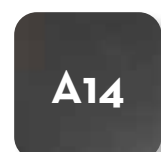

graphite

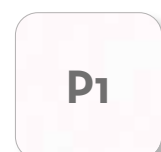

white



dark grey

Waterproof fabric canopy

Features

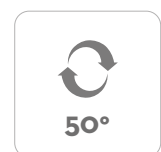

- 1-Telo 3x3 in tessuto da 250g in poliestere trattato in PU.
- 2-Optional: illuminazione a batteria ricaricabile.
- 3-Sistema di apertura retrattile che permette la chiusura parallela al palo. Sistema di apertura e chiusura del telo tramite manovella manuale removibile. Inclinabile fino a 50° su ambedue i lati.
- Il palo girevole permette all'ombrellone di ruotare di 360°.
- 4-Basamento in granito (125 kg) con ruote.
- 5-Optional: illuminazione con impianto audio per collegamento dispositivi Bluetooth.

- 1-Canopy 3x3 in 250g polyester with PU coating.
- 2-Optional: umbrella lights with rechargeable battery.
- 3-Retractable opening system allows umbrella closure parallel to the pole. Canopy opening/closure with removable hand crank. Reclining up to 50° on both sides. Turning pole allows parasol a 360° rotation.
- 4-Granite base (125 kg) with wheels.
- 5-Optional: umbrella Bluetooth speaker with led lights.

Specifiche:
 Palo in alluminio 90x65 mm
 7 Stecche in alluminio 28x14 mm
 Altezza ombrellone 280 cm
 Telo UV80+
 Basamento granito 125 kg 80x80x7 cm
 In caso di condizioni avverse chiudere l'ombrellone per evitare danni alla struttura, a cose e persone.

Technical specifications:
 Aluminium Pole 90x65 mm
 No.7 aluminium ribs 28x14 mm
 Parasol height 280 cm
 UV80+ Canopy
 Granite base 125 Kg 80x80x8 cm
 In case of bad weather conditions, we strongly recommend to close the parasol in order to avoid damages to the structure, to objects and persons.





Parasolcollection
//Marte







Parasolcollection

//Marte

MARTE 3x3 / CODE: PARMAR



Finishing

Aluminium frame



Waterproof fabric canopy



Features

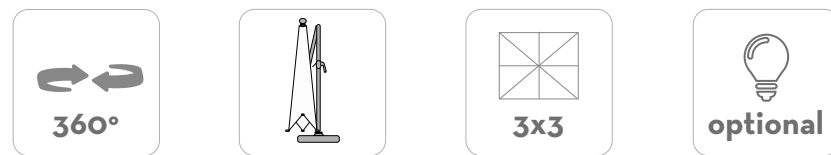

- 1-Telo 3x3 in tessuto da 250g in poliestere trattato in PU.
- 2-Optional: illuminazione a batteria ricaricabile.
- 3-Sistema di apertura retrattile che permette la chiusura parallela al palo.
Sistema di apertura e chiusura del telo tramite manovella manuale removibile.
- 4-Basamento in cemento (90 kg) con ruote, di colore bianco o mokka in tinta alla struttura.
Il palo girevole permette all'ombrellone di ruotare di 360°.
- 5-Optional: illuminazione con impianto audio per collegamento dispositivi Bluetooth.

- 1-Canopy 3x3 in 250g polyester with PU coating.
- 2-Optional: umbrella lights with rechargeable battery.
- 3-Retractable opening system allows umbrella closure parallel to the pole.
Canopy opening/closure with removable hand crank.
- 4-Concrete base (90kg) with wheels, available in white or mokka colour.
Turning pole allows parasol a 360° rotation.
- 5-Optional: umbrella Bluetooth speaker with led lights.

Specifiche:
 Palo in alluminio 80x65 mm
 7 Stecche in alluminio 28x14 mm
 Altezza ombrellone 290 cm
 Telo UV80+
 Basamento in cemento 90 kg 70x70x8 cm
 In caso di condizioni avverse chiudere l'ombrellone per evitare danni alla struttura, a cose e persone.

Technical specifications:
 Aluminium Pole 80x65 mm
 No.7 aluminium ribs 28x14 mm
 Parasol height 290 cm
 UV80+ Canopy
 Concrete base 90 Kg70x70x8 cm
 In case of bad weather conditions, we strongly recommend to close the parasol in order to avoid damages to the structure, to objects and persons.

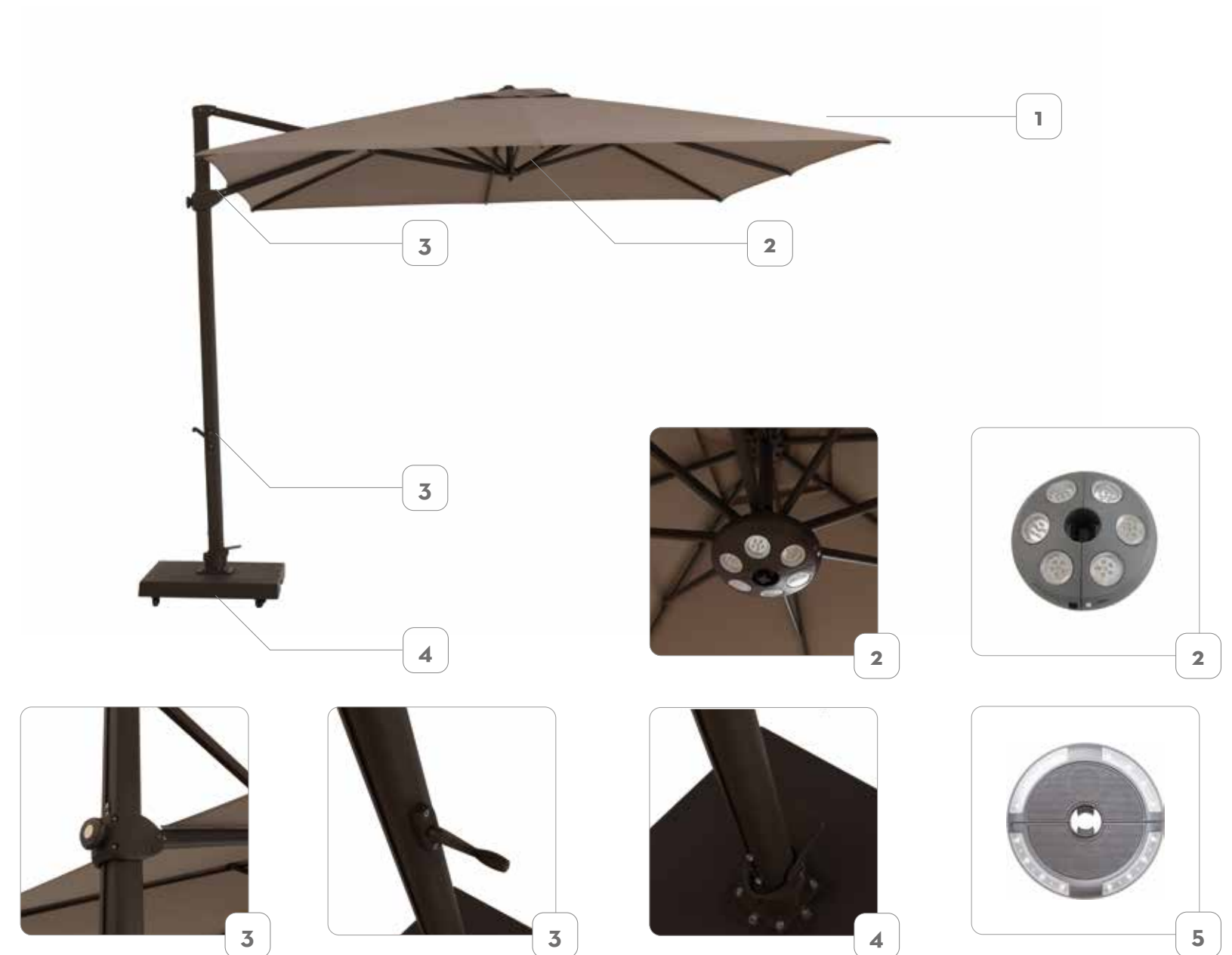



Parasolcollection
// Vulcano



Parasolcollection

// Vulcano

VULCANO 3x3 / CODE: PARVUL

KG 24,0 | unit 1 0.17 mc | ☀️ | 🔑

P1 A12



Finishing

Aluminium frame

Waterproof fabric canopy

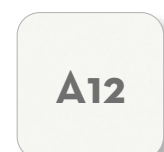

white

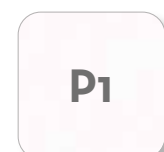

white

Features

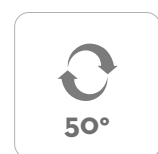

- 1-Telo 3x3 in tessuto da 250g in poliestere trattato in PU.
- 2-Optional: illuminazione a batteria ricaricabile.
- 3-Sistema di apertura retrattile che permette la chiusura parallela al palo.
- Sistema di apertura e chiusura del telo tramite manovella manuale removibile.
- Inclinabile fino a 50° su ambedue i lati.
- 4-Basamento con crociera in acciaio colore bianco. Per una stabilità ottimale si consiglia l'utilizzo di n.4 piastre in graniglia 50x50x4cm (pesi non inclusi).
- Il palo girevole permette all'ombrellone di ruotare di 360°.
- 5-Optional: illuminazione con impianto audio per collegamento dispositivi Bluetooth.

- 1-Canopy 3x3 in 250g polyester with PU coating.
- 2-Optional: umbrella lights with rechargeable battery.
- 3-Retractable opening system allows umbrella closure parallel to the pole.
- Canopy opening/closure with removable hand crank. Reclining up to 50° on both sides.
- 4-Steel white cross base with 4 grit plates. For a better stability we recommend you to use 4 grit plates 50x50x4cm (weights not included).
- Turning pole allows parasol a 360° rotation.
- 5-Optional: umbrella Bluetooth speaker with led lights.

Specifiche:
 Palo in alluminio 80x60 mm
 8 Stecche in alluminio 20x14 mm
 Altezza ombrellone 280 cm
 Telo UV80+
 Basamento con 4 piastre in graniglia 50x50x4 cm (pesi non inclusi)
 In caso di condizioni avverse chiudere l'ombrellone per evitare danni alla struttura, a cose e persone.

Technical specifications:
 Aluminium Pole 80x60 mm
 No.8 aluminium ribs 20x14 mm
 Parasol height 280 cm
 UV80+ Canopy
 Base with 4 grit plates in size 50x50x4 cm(Weights not included)
 In case of bad weather conditions, we strongly recommend to close the parasol in order to avoid damages to the structure, to objects and persons.





Parasolcollection
// Apollo



Parasolcollection

// Apollo

APOLLO 2x2 / CODE: PARAPO



Finishing

Aluminium frame



white



dove



grahite

Waterproof fabric canopy

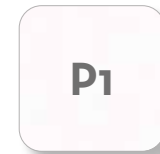

white



dark grey



dove

Features

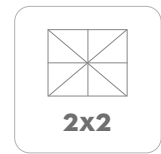
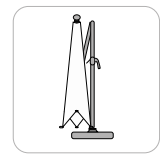

2x2

- 1 - Telo 2x2 in tessuto da 220g in poliestere trattato in PU.
- 2 - Sistema di apertura semplice ed intuitivo, spingere il tetto dell'ombrellone verso l'alto finché il meccanismo non si arresta.
- 3 - Puntale in alluminio cromato.
- 4 - Basamento in acciaio colore bianco da 40 kg.

- 1 - Canopy 2x2 in 250g polyester with PU coating.
- 2 - Easily parasol opening: push upwards the parasol roof until it locks.
- 3 - Chrome-plated alu tip.
- 4 - Steel white base 40 Kg.

Specifiche:
 Palo in alluminio ø 38 mm
 4 Stecche in alluminio ø 20 mm
 Altezza ombrellone 245 cm
 Telo UV80+
 Basamento in acciaio 40 kg 50x50x2 cm
 In caso di condizioni avverse chiudere l'ombrellone per evitare danni alla struttura, a cose e persone.

Technical specifications:
 Aluminium pole diam. 38 mm
 Parasol height 250 cm
 No. 4 aluminium ribs diam. 20 mm
 UV80+ Canopy
 Steel base 40 Kg 50x50x2 cm
 In case of bad weather conditions, we strongly recommend to close the parasol in order to avoid damages to the structure, to objects and persons.

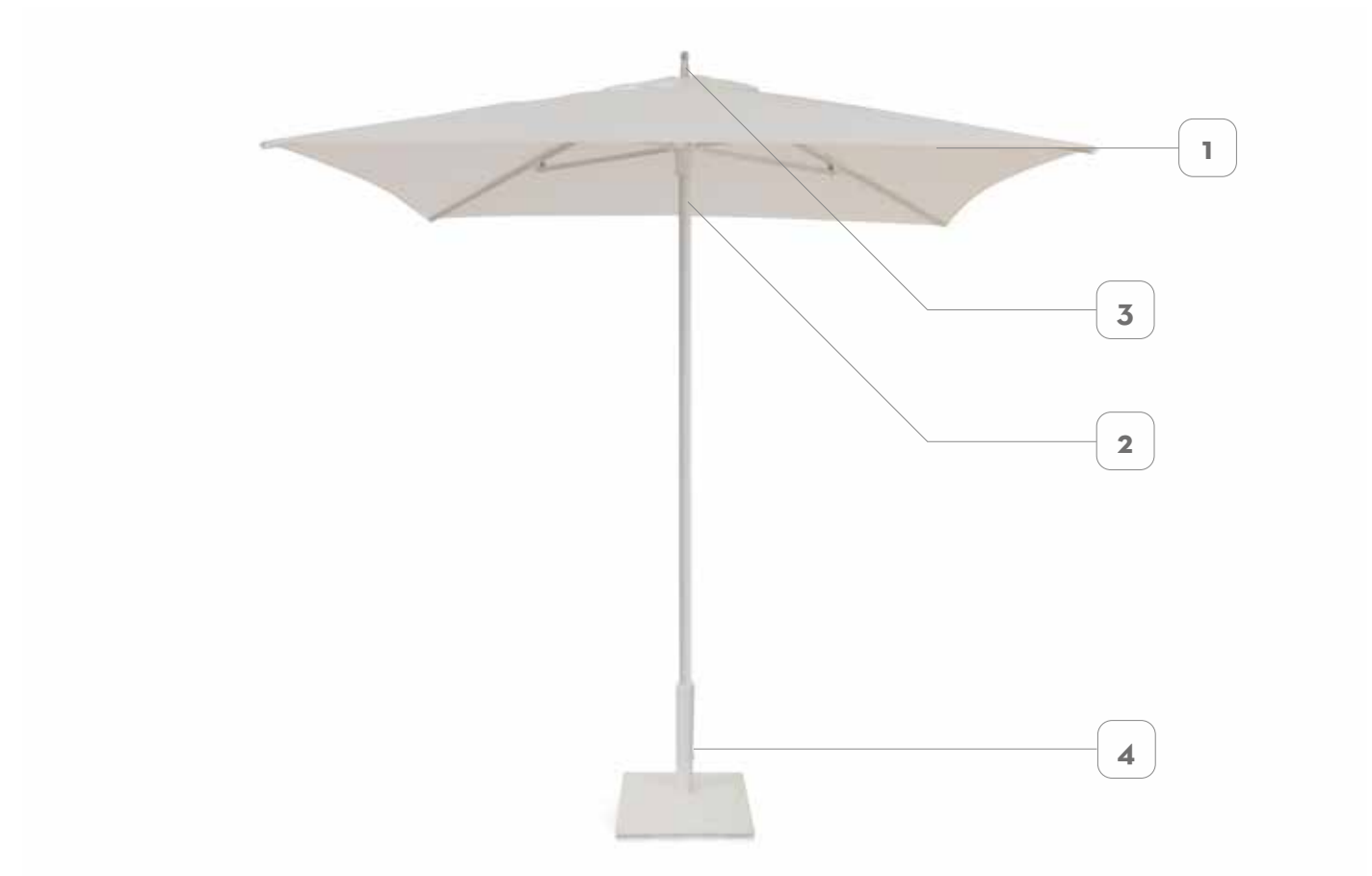



Jackiecollection





Jackiecollection

small, medium & big pouf
rope in dark grey colour











Jackiecollection

small & big lamp
rope in dove colour







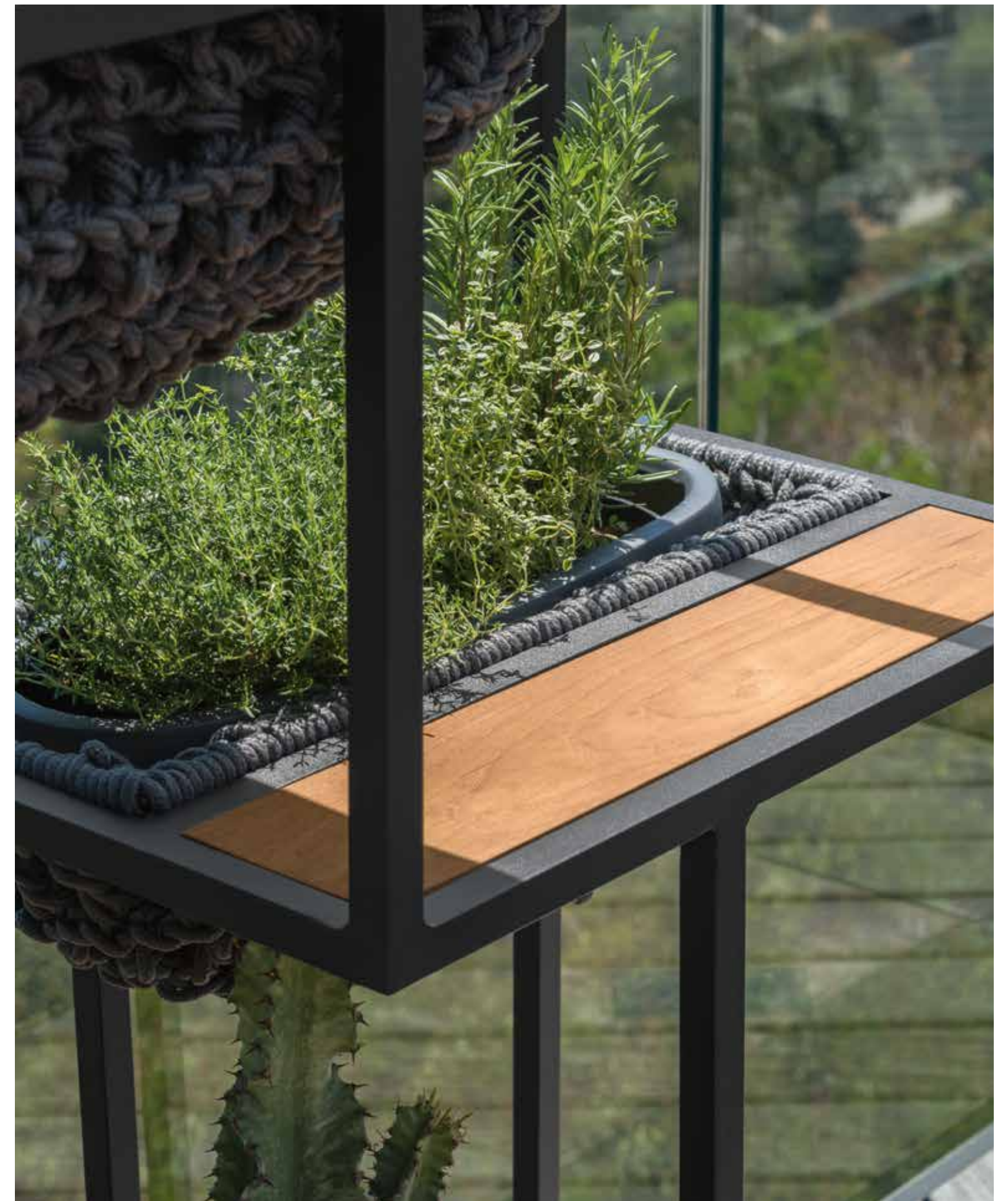

Jackiecollection

planter
white colour
rope in light grey colour

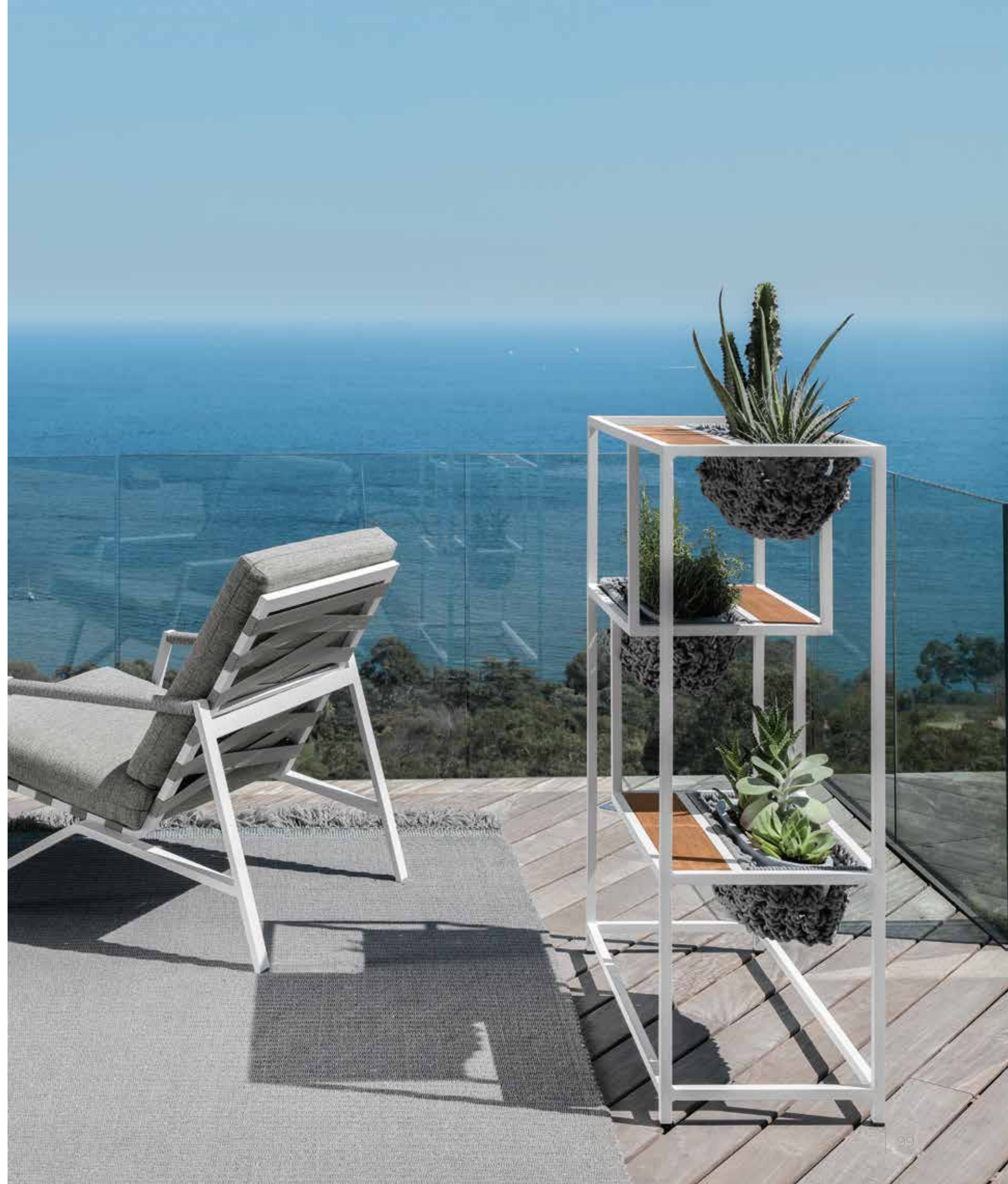

Jackiecollection

Finishing

Aluminium frame



white



graphite

Steel frame



white



graphite

Synthetic ropes



dove



light grey



dark grey



hunter green

Wood slats



teak

BEAN BAG / CODE: JACBAG



	Width	Depth	Height
cm	167	117	62
inch	65,7	46,1	24,4



LIVING ARMCHAIR / CODE: JACPL



	Width	Depth	Height	H.arm	H.seat
cm	78	80	73	57	35
inch	30,7	31,5	28,7	22,4	13,8

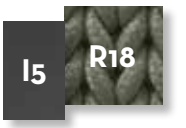
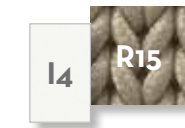

POUF SMALL / CODE: JACPUFP



	Width	Depth	Height
cm	56	56	26
inch	22,0	22,0	10,2

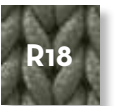

POUF MEDIUM / CODE: JACPUFM



	Width	Depth	Height
cm	64	64	32
inch	25,2	25,2	12,6

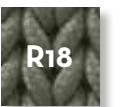

POUF BIG / CODE: JACPUFG



	Width	Depth	Height
cm	83	83	38
inch	32,7	32,7	15,0



LAMP SMALL / CODE: JACLAMPP



	Width	Depth	Height
cm	55	55	42
inch	21,7	21,7	16,5



LAMP BIG / CODE: JACLAMPG



	Width	Depth	Height
cm	70	70	60
inch	27,6	27,6	23,6



FLOOR LAMP / CODE: JACLAMPT



	Width	Depth	Height
cm	21,7	21,7	59,1
inch	21,7	21,7	59,1

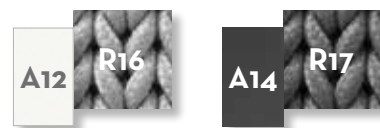

BASKET / CODE: JACBAK



	Width	Depth	Height
cm	55	55	30
inch	21,7	21,7	11,8



PLANTER / CODE: JACPLAN



	Width	Depth	Height
cm	90	40	120
inch	35,4	15,7	47,2

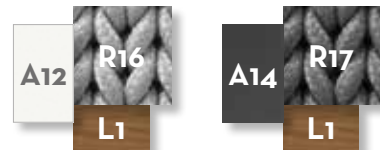



Carpetcollection

// Quadro

// Ribs





// Ribs





// Quadro



// Quadro



Carpet collection

// Quadro
// Ribs

Finishing

Fabric quadro



canvas



light grey



dark grey



red



dark green

Fabric ribs



canvas



light grey



dark grey



dark green

QUADRO 400x300 / CODE: TAPQ3

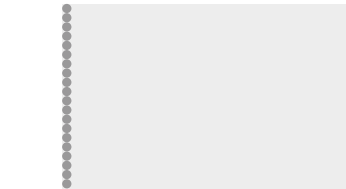

Width	Depth
cm 400	300
inch 157,5	118,1

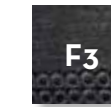

KG 48,0 | unit 1 0.32 mc |

QUADRO 300x200 / CODE: TAPQ1

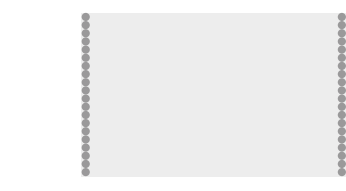

Width	Depth
cm 300	200
inch 118,1	78,7

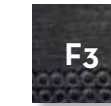

KG 30,0 | unit 1 0.27 mc |

QUADRO 240x160 / CODE: TAPQ2



Width	Depth
cm 240	160
inch 94,5	63,0

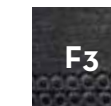

KG 15,0 | unit 1 0.18 mc |

RIBS 400x300 / CODE: TAPR3

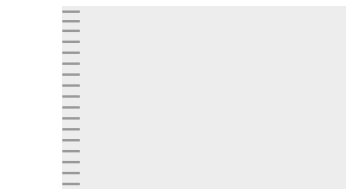

Width	Depth
cm 400	300
inch 157,5	118,1

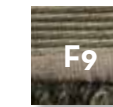
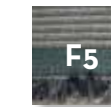
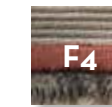

KG 48,0 | unit 1 0.32 mc |

RIBS 300x200 / CODE: TAPR1



Width	Depth
cm 300	200
inch 118,1	78,7

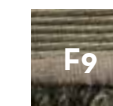
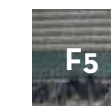

KG 30,0 | unit 1 0.27 mc |

RIBS 240x160 / CODE: TAPR2



Width	Depth
cm 240	160
inch 94,5	63,0

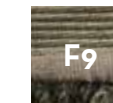
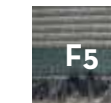

KG 15,0 | unit 1 0.18 mc |

QUADRO DIAM 300 / CODE: TAPQ4

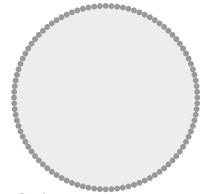

Width 300 | Depth 300
cm
inch 118,1 | 118,1

KG 50,0 | unit 1 0,32 mc

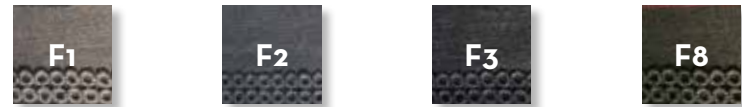

QUADRO DIAM 200 / CODE: TAPQ5

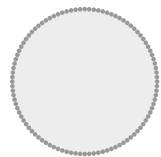

Width 200 | Depth 200
cm
inch 78,7 | 78,7

KG 30,0 | unit 1 0,27 mc

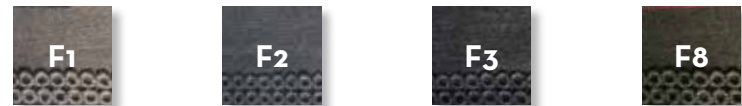



Gabricollection
Design Studio Talenti



Gabri collection

Design Studio Talenti

Finishing

Terrazzo table top



beige



grey



red

COFFEE TABLE H45 / CODE: GABTL45



	Width	Depth	Height
cm	40	40	45
inch	15,7	15,7	17,7

KG 11,0 | unit 1 0.10 mc |

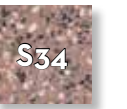

COFFEE TABLE H55 / CODE: GABTL55



	Width	Depth	Height
cm	40	40	55
inch	15,7	15,7	21,7

KG 12,0 | unit 1 0.12 mc |

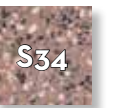



Plazacollection
Design Marco Acerbis





Plazacollection

coffee table d45 & coffee table 80x65
grey cement colour

Plazacollection

Design Marco Acerbis

Finishing

Concrete table top



beige cement



grey cement



blue cement

PLAZA COFFEE TABLE D45 / CODE: PLATC45



	Width	Depth	Height
cm	45	45	48
inch	112.2	37.4	27.6

KG 23,0 | unit 1 0.17 mc |

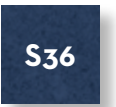
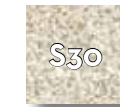

PLAZA COFFEE TABLE 80X65 / CODE: PLATC8065



	Width	Depth	Height
cm	80	65	35
inch	112.2	37.4	27.6

KG 45,0 | unit 1 0.30 mc |

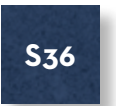
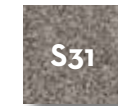
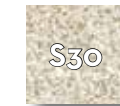



Casildacollection
// Lamps
Design Ramón Esteve



Casilda collection // Lamps

Design Ramón Esteve

Finishing

Stainless steel frame



Accoya wood table top

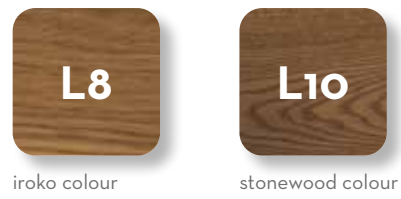

LAMP L / CODE: CASILAMPL



	Width	Depth	Height
cm	23	20	175
inch	9,1	7,9	68,9

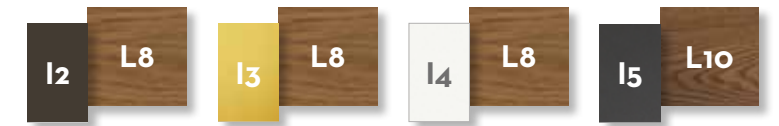

LAMP S / CODE: CASILAMPS



	Width	Depth	Height
cm	63	15	40
inch	24,8	5,9	15,7

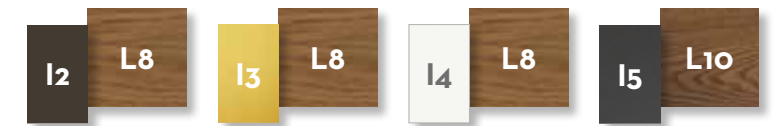

LAMP XS / CODE: CASILAMPXS



	Width	Depth	Height
cm	23	20	40
inch	9,1	7,9	15,7

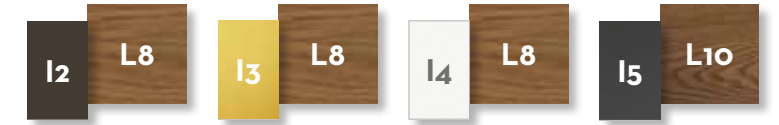
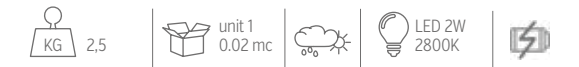



Tribalcollection

// Lamps

Design Ludovica + Roberto Palomba

Tribalcollection

small, medium & big lamp
dove frame
sand colour rope



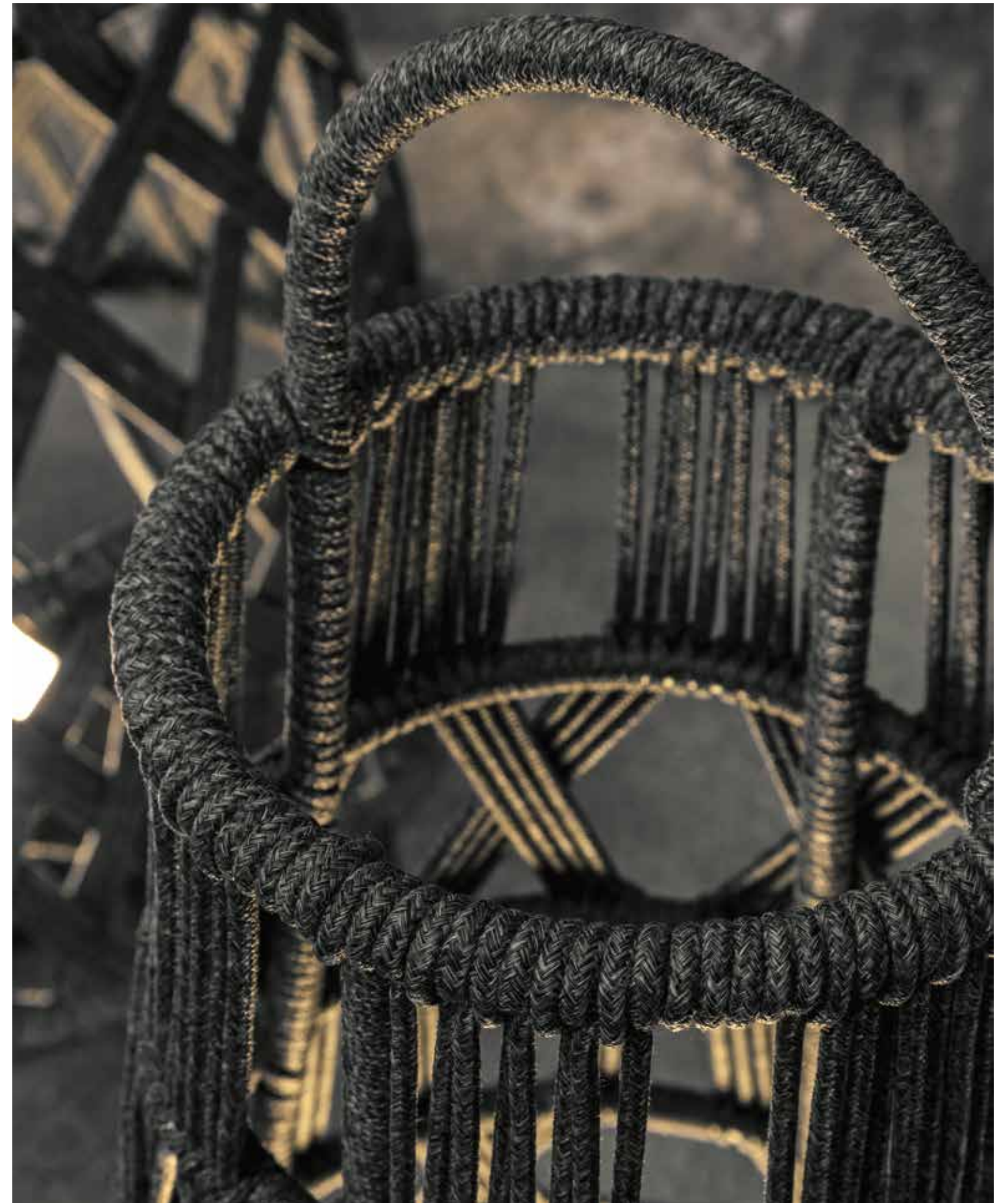

Tribalcollection

small, medium & big lamp
red frame
red colour rope

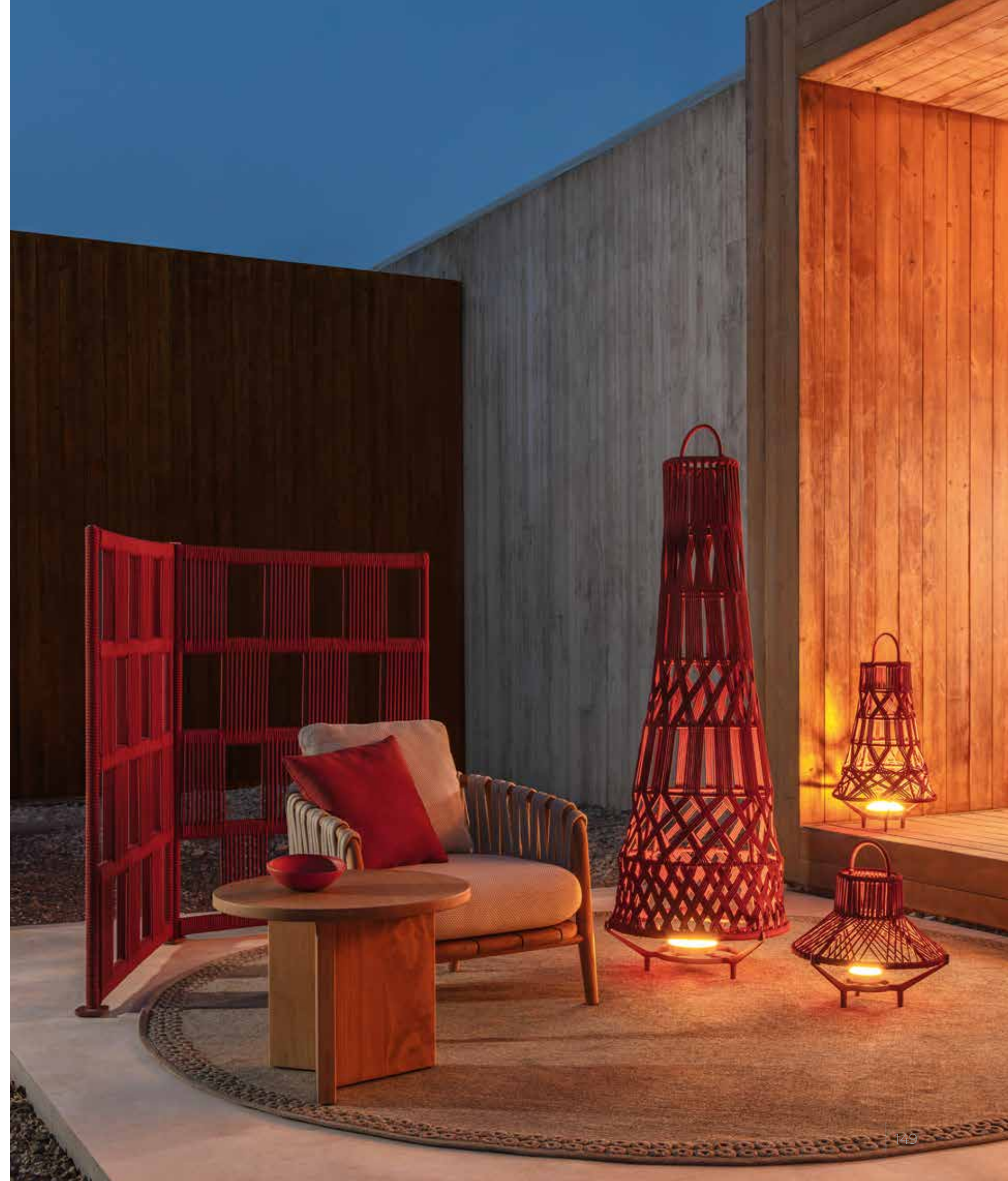



Tribal collection // Lamps

Design Ludovica + Roberto Palomba

Finishing

Aluminium frame



Synthetic rope

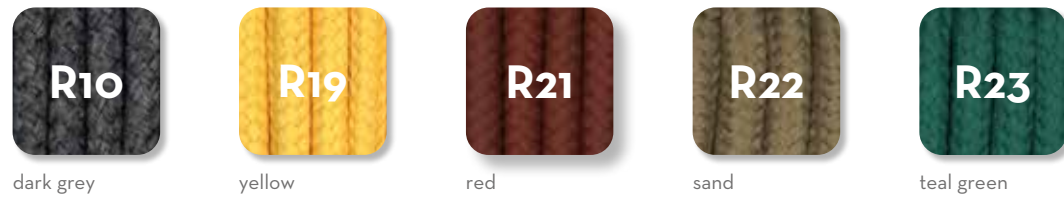

TRIBAL BIG / CODE: TRIB01



	Width	Depth	Height
cm	60	60	175
inch	23,6	23,6	68,9



TRIBAL MEDIUM / CODE: TRIB02



	Width	Depth	Height
cm	45	45	85
inch	17,7	17,7	33,5



TRIBAL SMALL / CODE: TRIB03



	Width	Depth	Height
cm	45	45	45
inch	17,7	17,7	17,7



TRIBAL CELIN / CODE: TRIB04



	Width	Depth	Height
cm	45	45	71
inch	17,7	17,7	28,0





Cleocollection
// Lamps
Design Marco Acerbis









Cleo collection // Lamps

Design Marco Acerbis

Finishing

Aluminium frame



white



graphite

Stainless steel frame



white



graphite



dove

LANTERN H66 / CODE: CLEL01



	Width	Depth	Height
cm	35	35	66
inch	13,8	13,8	26,0

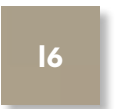
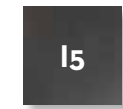

LANTERN H90 / CODE: CLEL02



	Width	Depth	Height
cm	40	40	90
inch	15,7	15,7	35,4

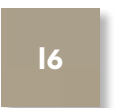
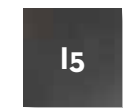

LANTERN H120 / CODE: CLEL03



	Width	Depth	Height
cm	45	45	120
inch	17,7	17,7	47,2

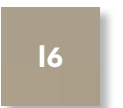
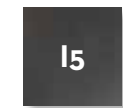

ARC LAMP / CODE: CLEALUL02



	Width	Depth	Height
cm	201	42	225
inch	79,1	16,5	88,6

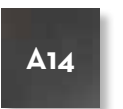



Todcollection
// Lamps
Design Marco Acerbis



Tod collection // Lamps

Design Marco Acerbis

LAMP / CODE: TODLAMP



	Width	Depth	Height
cm	55	55	150
inch	21.7	21.7	59.1

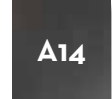

Finishing

Aluminium frame



white



graphite



Kukàcollection
Design Studio Adolini





Kukàcollection

medium & big lamp
graphite and sand colour
planter diam 40 cm in sand colour
planter diam 60 cm in graphite colour





Kukà collection

Design Studio Adolini

Finishing

Eco-resin for Lamp / Coffee Table

Cylindrical frame



Sand



Graphite



Trasparent PMMA

Leather belt



brown

Cement for Planter



Sand



Graphite

BIG LAMP / CODE: KUKL01

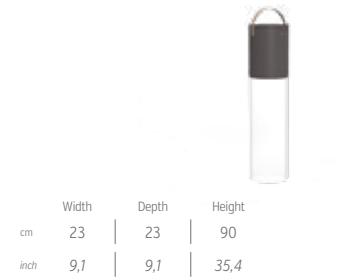

MEDIUM LAMP / CODE: KUKL02



SMALL LAMP / CODE: KUKL03

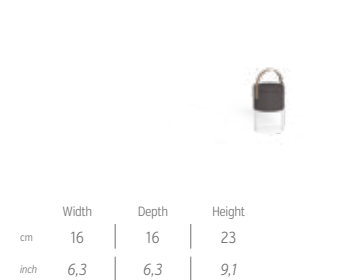

COFFEE TABLE D50 / CODE: KUKTC50



COFFEE TABLE D80 / CODE: KUKTC80



PLANTER D60 / CODE: KUKP60



	Width	Depth	Height
cm	60	60	60
inch	23,6	23,6	23,6

PLANTER D40 / CODE: KUKP40



	Width	Depth	Height
cm	40	40	70
inch	15,7	15,7	27,6





Malècollection
// Lamps
Design Ludovica + Roberto Palomba





Malécollection

small & big lamp
white colour

Malécollection

small & big lamp
dove & graphite colour



Malè collection // Lamps

Design Ludovica + Roberto Palomba

Finishing

Stainless steel frame

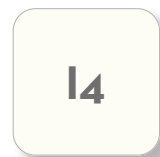

white



graphite



dove

Translucent polyethylene



white



dove



graphite

LAMP H190 / CODE: MALL190



	Width	Depth	Height
cm	52	52	190
inch	20,5	20,5	74,8

KG 23,0 |
 unit 1 0.60 mc |
 |
 LED 98W 4000K |
 220v

I4 PE1t |
 I6 PE2t |
 I5 PE3t

LAMP H90 / CODE: MALL90



	Width	Depth	Height
cm	52	52	90
inch	20,5	20,5	35,4

KG 15,0 |
 unit 1 0.26 mc |
 |
 LED 48W 4000K |
 220v

I4 PE1t |
 I6 PE2t |
 I5 PE3t



Coralcollection

// Lamps

Design Marco Acerbis



Coralcollection

small, medium & big lamp
rope in graphite colour
graphite colour frame



Coral collection // Lamps

Design Marco Acerbis

Finishing

Aluminium frame



white



graphite

Synthetic ropes

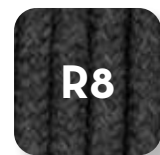

dark grey



beige

Wood



teak

LAMP H125/ CODE: CORLAMPH125



	Width	Depth	Height
cm	28	28	125
inch	11,0	11,0	49,2

9,5 KG |
 unit 1 0.14 mc |
 |
 LED 7W 2800K |

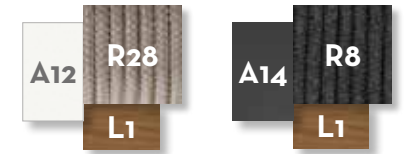

LAMP H95/ CODE: CORLAMPH95



	Width	Depth	Height
cm	28	28	95
inch	11,0	11,0	37,4

8,5 KG |
 unit 1 0.11 mc |
 |
 LED 7W 2800K |

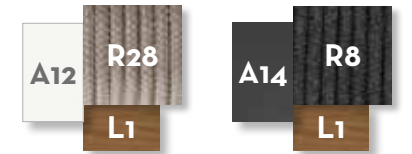

LAMP H45/ CODE: CORLAMPH45



	Width	Depth	Height
cm	28	28	45
inch	11,0	11,0	17,7

6,0 KG |
 unit 1 0.04 mc |
 |
 LED 3.5W 2800K |

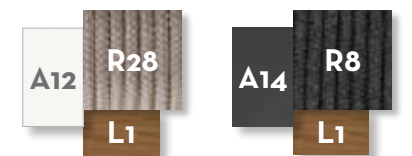



Toffeecollection
// Lamps





Toffee collection // Lamps

Finishing

Aluminium frame



white

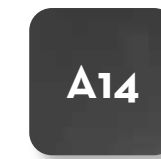

graphite

TOFEE / CODE: TOF01

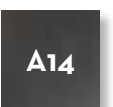

	Width	Depth	Height
cm	11	11	19
inch	4,3	4,3	7,5



Scaccocollection

// Partition

Design Ludovica + Roberto Palomba



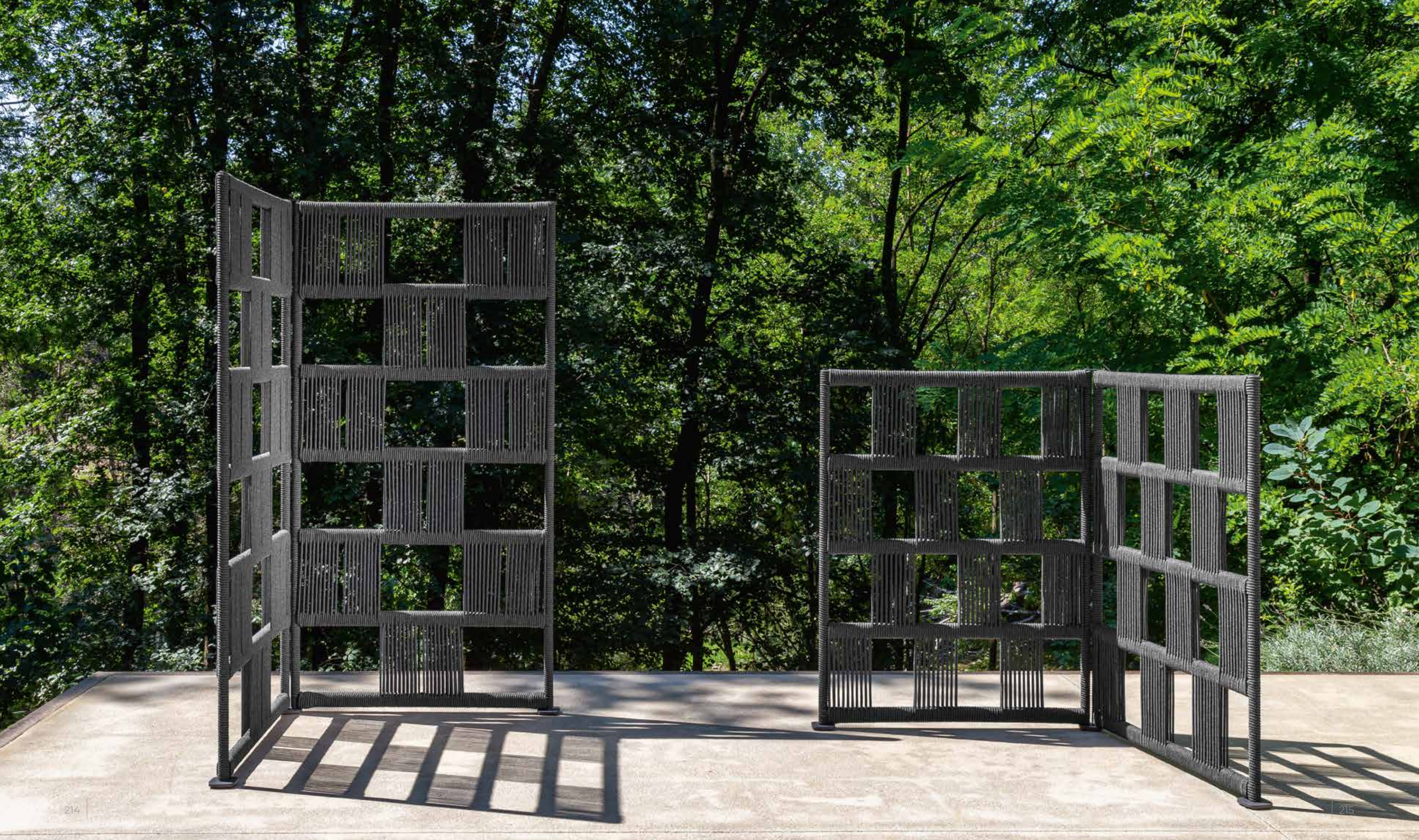



Scacco collection

// Partition

Finishing

Aluminium frame



graphite



beige

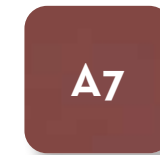

red

Syntetic rope



beige



dark grey



red

PARTITION H135 / CODE: SCAPAR135



	Width	Depth	Height
cm	100	5	135
inch	39,4	2,0	53,1



PARTITION H200 / CODE: SCAPAR200

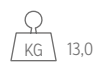

	Width	Depth	Height
cm	100	5	200
inch	39,4	2,0	78,7





Tikalcollection
Design Nicola de Pellegrini





Finishing

Metal frame

Doors frame



magnesit black



magnesit white



accoya wood natural teak colour

KITCHEN CHEST / CODE: TIKMAD

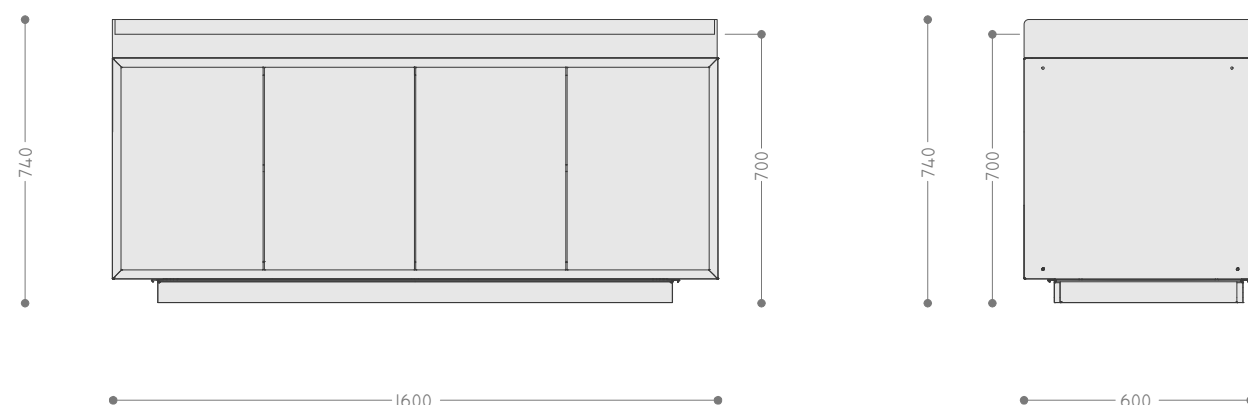
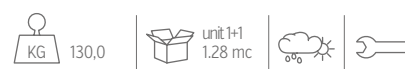

Madia

Struttura in acciaio zinco magnesio e alluminio (Magnesit), verniciatura bianco RAL 9003 o nero RAL 9004 alte temperature testurizzato.

4 ante a battente disponibili o in magnesit o in legno di accoya tinto natural teak con maniglia ad incasso gola, apertura 125° a sgancio rapido e chiusura blumotion. Top in gres.
Misure 1600x600x740 h - peso 130 kg.
Dimensioni interne del vano 65x54x49 h

Kitchen chest

Structure in zinc magnesium steel and aluminium (Magnesit), white RAL 9003 or black RAL 9004 high temperature, textured painting. 4 swing doors available in magnesit or in accoya wood, natural teak colored with recessed handles, fast release 125° opening and blumotion latch. Gres top.
Dimensions: 1600x600x740 h - weight 130 kg.
Internal dimensions of the compartment 65x54x49 h

SHELF MODULE 120X190 / CODE: TIKSCA120

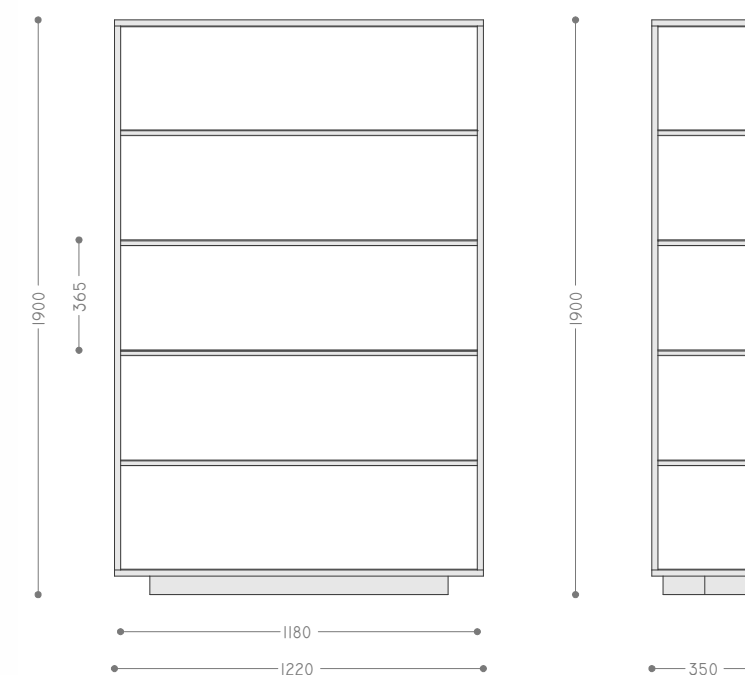

Modulo scaffale 120x190

Struttura in acciaio zinco magnesio e alluminio (Magnesit), verniciatura bianco RAL 9003 o nero RAL 9004 alte temperature testurizzato.

Scaffale con mensole metalliche removibili e regolabili. Misure 1220x1900x350 - peso 50 kg

Shelf module 120x190

Structure in zinc magnesium steel and aluminium (Magnesit), white RAL 9003 or black RAL 9004 high temperature, textured painting.

Shelf with removable and adjustable metal shelves. Dimensions 1220x1900x350 - weight 50 kg

SUSPENDED CABINET WITH FLAP DOOR 118X36 / CODE: TIKSCA120M



Pensile con anta a ribalta 118x36

Struttura in acciaio zinco magnesio e alluminio (Magnesit), verniciatura bianco RAL 9003 o nero RAL 9004 alte temperature testurizzato.

Anta a ribalta con maniglia ad incasso gola, apertura 107° e chiusura blumotion. Misure 1180x365x350 - peso 20 kg
*abbinabile solo al modulo scaffale 120x190

Suspended cabinet with flap door 118x36

Structure in zinc magnesium steel and aluminium (Magnesit), white RAL 9003 or black RAL 9004 high temperature, textured painting.

Flap door with recessed handles, 107° opening and blumotion latch. Dimensions 1180x365x350 - weight 20 kg
*only compatible with shelf module 120x190

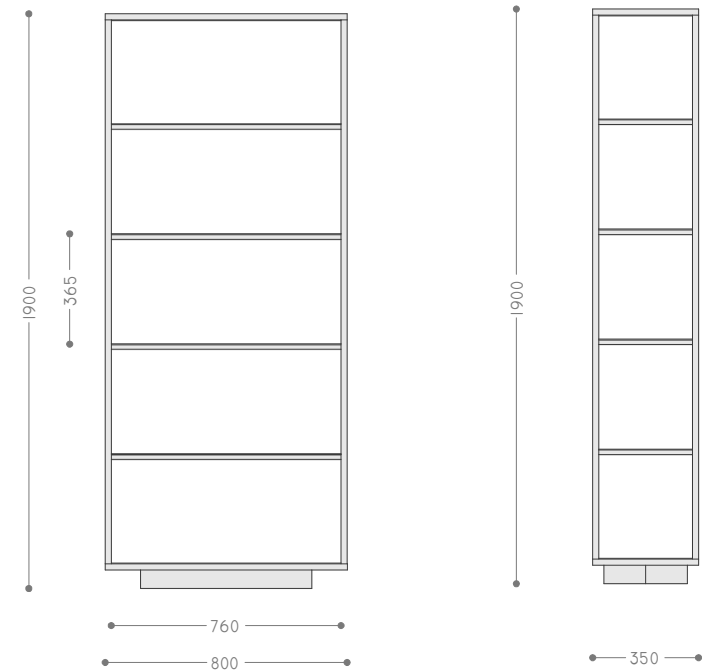

Modulo scaffale 80x190

Struttura in acciaio zinco magnesio e alluminio (Magnesit), verniciatura bianco o nero RAL 9004 alte temperature testurizzato. Scaffale con mensole metalliche removibili e regolabili. Misure 800x1900x350 - peso 40 kg

Shelf module 80x190

Structure in zinc magnesium steel and aluminium (Magnesit), white or black RAL 9004 high temperature, textured painting. Shelf with removable and adjustable metal shelves. Dimensions: 800x1900x350 - weight 40 kg

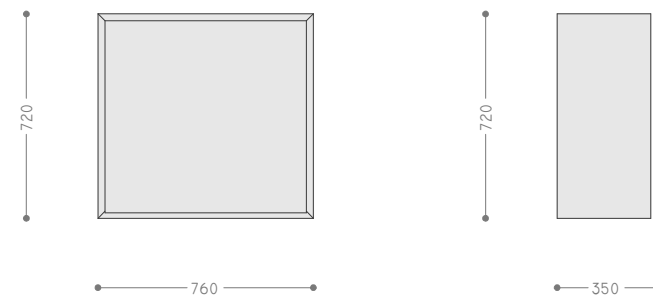

Mobile base 76x72

Struttura in acciaio zinco magnesio e alluminio (Magnesit), verniciatura bianco o nero RAL 9004 alte temperature testurizzato. Anta a battente con maniglia ad incasso gola, apertura 125° a sgancio rapido e chiusura blumotion. Misure 760x700x350 - peso 25 kg
*abbinabile solo al modulo scaffale 80x190

Cabinet base 76x72

Structure in zinc magnesium steel and aluminium (Magnesit), white or black RAL 9004 high temperature, textured painting. Swing door with recessed handles, fast release 125° opening and blumotion latch. Dimensions 760x700x350 - weight 25 kg
*only compatible with shelf module 80x190





Showergatecollection
Design Marco Acerbis



Showergate collection

Design Marco Acerbis

SHOWER GATE / CODE: DCCG01



	Width	Depth	Height
cm	90	100	220
inch	35,4	39,4	86,6

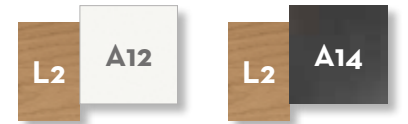

Finishing

Alluminium frame



white

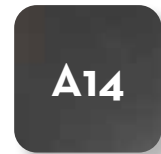

graphite

Wood base



accoya natural teak colour



Pathcollection

// Planter

Design Filippo Cagnotto



Pathcollection

planter h85 / h100 / h120
graphite colour frame



Path collection // Planter

Design Filippo Cagnotto

Finishing

Stainless steel frame



white



graphite

PLANTER H85 / CODE: PAT85



	Width	Depth	Height
cm	100	40	85
inch	39,4	15,7	33,5

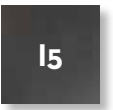

PLANTER H100 / CODE: PAT100



	Width	Depth	Height
cm	100	40	100
inch	39,4	15,7	39,4

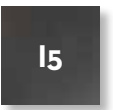

PLANTER H120 / CODE: PAT120



	Width	Depth	Height
cm	100	40	120
inch	39,4	15,7	47,2

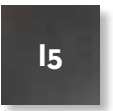

PLANTER+HANDRAIL H85/ CODE: PAT85H



	Width	Depth	Planter H.	Handrail H.
cm	100	40	85	93
inch	39,4	15,7	33,5	36,6

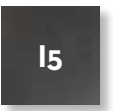

PLANTER+HANDRAIL H100/ CODE: PAT100H



	Width	Depth	Planter H.	Handrail H.
cm	100	40	100	93
inch	39,4	15,7	39,4	36,6

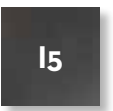

PLANTER+HANDRAIL H120/ CODE: PAT120H



	Width	Depth	Planter H.	Handrail H.
cm	100	40	120	93
inch	39,4	15,7	47,2	36,6

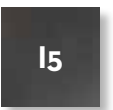



Cartcollection







Cartcollection

Finishing

Aluminium frame



white



dove

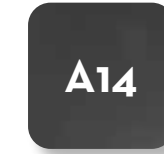

graphite

Wood slats



teak

CART / CODE: ACCCAR



	Width	Depth	Height	H.whe
cm	90	55	76	22
inch	35,4	21,7	29,9	8,7

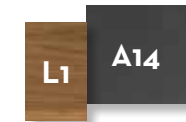
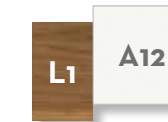



Raycollection





Raycollection

Aluminium frame



charcoal



graphite



dove

SMALL SERVING TABLE / CODE: RAYVP



	Width	Depth	Height
cm	60	60	45
inch	23,6	23,6	17,7

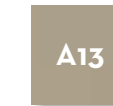
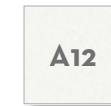
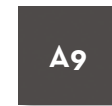

BIG SERVING TABLE / CODE: RAYVG



	Width	Depth	Height
cm	60	60	73
inch	23,6	23,6	28,7

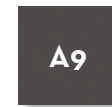



Boxcollection





Accessories collection

// Box

Finishing

Aluminium frame



white



dove

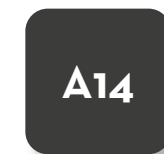

graphite

Textilene covering



white

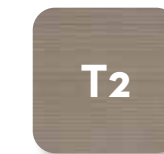

dove



silver black

BOX / CODE: BOXAL01



	Width	Depth	Height
cm	130	60	58
inch	51,2	23,6	22,8



Materials

Alluminio / Aluminium



Teal green



Red



Charcoal



Silver



White



Dove colour



Graphite



Mokka

Alluminio: Grazie alla fusione di più leghe di alluminio che ne garantiscono solidità, maneggevolezza ed inattaccabilità alla ruggine, è un materiale di elevata qualità e permette di raggiungere i massimi risultati qualitativi ed estetici.

Inox: L'acciaio inossidabile è un materiale che, grazie alla sua alta resistenza alla corrosione e alle caratteristiche meccaniche di rilievo, risulta maggiormente duraturo e affidabile nel tempo.

Acciaio: Lega di ferro e carbonio con percentuale di carbonio inferiore al 2% trattata per resistere agli agenti atmosferici con il processo della cataforesi e verniciatura a polvere.

Manutenzione: Per mantenere a lungo il prodotto in buone condizioni, consigliamo una corretta pulizia periodica, particolarmente frequente in località caratterizzate da forte umidità e clima marino. Si raccomanda di pulire le superfici con un panno morbido utilizzando acqua o detersivi neutri. Prolungate ed ininterrotte esposizioni a intense radiazioni UV o a temperature molto rigide possono incidere sulle caratteristiche iniziali del rivestimento estetico colorato costituito da poliestere. Consigliamo di pulire e conservare in luoghi riparati i prodotti durante periodi d'inutilizzo prolungato e invernali.

Aluminum: Thanks to the fusion of several aluminum alloys that guarantee solidity, manageability and rust resistance, it is a material of high quality and allows to reach the maximum qualitative and aesthetic results.

Inox: Stainless steel is a material that, thanks to its high resistance to corrosion and to the mechanical characteristics of relief, is more durable and reliable over time.

Steel: Iron and carbon alloy with carbon percentage less than 2% treated to resist to the atmospheric agents with the cathoresis process and powder coating.

Maintenance: To keep the product in good condition for a long time, we recommend a regular cleaning period, particularly frequent in places characterized by high humidity and marine climate. We recommend cleaning the surfaces with a soft cloth using water or neutral detergents. Prolonged and uninterrupted exposures to intense UV radiation or at very low temperatures can affect the initial characteristics of the colored polyester coating. We recommend cleaning and storing products in sheltered areas during long periods of non-use and winter.

Materials

Corde sintetiche / Synthetic ropes



Dark grey



Dark grey



Dove



Light grey

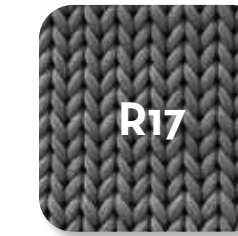

Dark grey

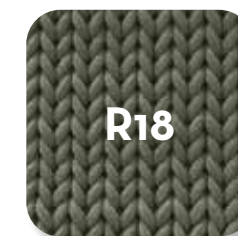

Hunter green



Yellow



Red



Sand



Teal green



Beige

Doppia treccia costruita con anima in poliestere e copertura in propilene multi filamento. La fibra esterna di cui è composta è impermeabile e resistente ai raggi UV.

Si raccomanda di pulire con prodotto neutro e panno non abrasivo.

Double braid made with polyester core and multi-filament propylene cover. The external fiber is waterproof and resistant to UV rays.

It is recommended to clean with a neutral product and a non-abrasive cloth.

Materials

Legni / Wood



L1

Teak

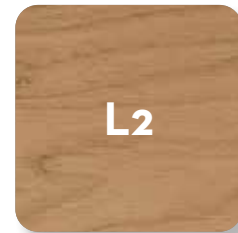

L2

Accoya natural teak colour

Teak: Materiale di elevata qualità ideale per la realizzazione di mobili da esterno perché estremamente resistente ai cambiamenti di temperatura, all'acqua, all'umidità e alla salsedine.

Trattandosi di un materiale naturale si potrebbero osservare variazioni di colore o anche crepe dovute al grado di umidità ed ai bruschi cambiamenti di temperatura. Qualora non ricevesse alcun trattamento di manutenzione, mediante l'applicazione periodica di comuni e specifici protettivi a base olio, la superficie potrebbe prendere una patina grigio argento che potrà essere eliminata con una leggera carteggiatura superficiale e successiva lucidatura con panno di iuta. Piccole macchie superficiali dovute ad olio o altri prodotti alimentari dovranno essere rimosse tempestivamente, prima che il legno possa assorbirle in profondità, carteggiando la superficie interessata e lucidandola successivamente con un panno di iuta.

Teak: High quality material suitable for outdoor furniture because it is extremely resistant to changes in temperature, water, humidity and saltiness.

Being a natural material, colour variations or even cracks due to the degree of humidity and sudden changes in temperature may be observed. If no maintenance treatment is received, through the periodic application of common and specific protective oil-based, the surface may take a silver-gray patina that can be easily removed with a light surface sanding down and subsequent polishing with a jute cloth. Small superficial stains due to oil or other food products must be removed promptly, before the wood can absorb them in depth, sanding down the affected surface and then polishing it with a jute cloth.

Materials

Tappeti / Carpet



F1

Canvas



F2

Light grey



F3

Dark grey



F7

Red



F8

Dark green



F4

Canvas



F6

Light grey



F6

Dark grey



F9

Dark green

I tappeti sono realizzati in filato di fibra sintetica, hanno un trattamento idrorepellente, antimacchia e antimuffa.

Il filato in PP ha una resa ottimale in ambienti esterni, per durata e resistenza agli agenti atmosferici ed ha un'elevata stabilità ai raggi UV.

Manutenzione quotidiana: aspirapolvere senza spazzole.

Manutenzione periodica: lavaggio a secco o pulizia a vapore.

Macchie: tamponare con un panno pulito; agire con detersivi specifici seguendo attentamente le istruzioni del produttore.

All the carpets are made of synthetic fabric and through a special treatment they are waterproof, stain-resistant and anti-bacterial. The PP yarn ensures an excellent performance in terms of long-lasting durability, weather and UV rays resistance.

Daily cleaning: vacuum cleaner without brushes.

Deeper cleaning: professional dry cleaning or steam cleaning.

Stains: pat the area with a clean cloth; use specific detergents following the manufacturer's instructions.

Materials

Tessuto 100% pl, idrorepellente / 100% pl fabric, water repellent



White



Dark grey



Dove

Il poliestere è un materiale adatto all'arredo esterno perchè semplice da pulire, trattare e lavare.

Ha elevate caratteristiche meccaniche: resiste alla rottura, alla luce, all'abrasione, non si deforma in modo permanente ed ha un ottimo recupero elastico.

È idrorepellente, quindi perfetto se installato vicino ad un bordo piscina o se esposto a situazioni climatiche avverse.

Prima di chiudere l'ombrellone è importante assicurarsi che il telo sia perfettamente asciutto.

Durante i mesi di non utilizzo l'ombrellone deve essere riposto in un ambiente asciutto e protetto dalla relativa cover. Evitare il contatto prolungato con sostanze grasse e/o coloranti che potrebbero venire assorbite dal materiale di rivestimento e dare luogo a macchie permanenti, oltre che deteriorare la struttura del filato. Non usare solventi. Utilizzare acqua e detersivi liquidi non abrasivi con PH neutro e incolore. Eventualmente lasciare agire il detersivo alcuni minuti. Sciacquare abbondantemente con acqua a temperatura non superiore a 30°C.

Polyester is a material suitable for outdoor furniture because it is easy to clean, treat and wash.

It has high flexural strength characteristics: it resists breakage, light, abrasion, does not deform permanently and has an excellent elastic shape recovery.

It is water repellent, therefore perfect if installed near swimming pool areas or if exposed to adverse weather conditions.

Before closing the parasol it is important to make sure that the cloth is perfectly dry.

During the months of not using the umbrella must be stored in a dry place and protected by the appropriate cover. Avoid prolonged contact with greasy substances which could be absorbed by the coating material and give rise to permanent stains, as well as deteriorating the yarn structure. Do not use solvents. Use water and non-abrasive liquid detergents with neutral PH and colourless. If necessary, allow the detergent to act for a few minutes. Rinse with water at a temperature not exceeding 30 ° C.

Materials

Textilene



White



Dove



Silver black

Il Textilene è una fibra di poliestere protetta da un rivestimento in PVC. Le fibre vengono poi legate insieme in modo da ottenere una sostanza fibrosa particolarmente solida e permanente, resistente allo stiramento ed immune da strappi.

La caratteristica più importante è la sua elasticità, offre un'eccellente resistenza alle muffe e alle macchie, e presenta un trattamento superficiale contro la degradazione UV.

Il textilene può essere pulito semplicemente con un panno di spugna con acqua saponata. Abrasivi e solventi devono essere assolutamente evitati!

Si asciuga molto rapidamente a causa della loro struttura aperta.

Textilene is a polyester fiber protected by a PVC coating. The fibers are bonded together so in order to obtain a particularly solid fibrous material which is durable, resistant to stretching and wear resistant too.

The most important characteristic is its elasticity, offers excellent resistance to inhibits mold and stains, and has a surface treatment against UV degradation.

Textilene can simply be cleaned with a sponge cloth with soapy water. Abrasives and solvents must absolutely be avoided!

It dries very quickly due to their open structure.

Materials

Textilene



T21

White



T22

Taupe



T23

Red

Tessuto tecnico microforato in poliestere spalmato PVC per la protezione solare. Tessuto leggero filtrante per garantire il giusto apporto di luce naturale, elevata stabilità dimensionale e resistenza meccanica.

Equilibrio ideale tra protezione termica e comfort visivo, ottima visibilità verso l'esterno con una trama regolare. Stabile dimensionalmente. Resistente alle intemperie e ai raggi UV. Leggero, durevole, 100% riciclabile. Ignifugo.

Per la pulizia si consiglia di utilizzare un panno di spugna con acqua saponata. Abrasivi e solventi devono essere assolutamente evitati! Si asciuga molto rapidamente a causa della loro struttura aperta.

Micro-perforated technical fabric in PVC coated polyester for sun protection. Light filtering fabric to ensure the right amount of natural light, high dimensional stability and mechanical resistance.

Ideal balance between thermal protection and visual comfort, excellent visibility towards the outdoor with a regular weave. Stable dimensionally. Weatherproof and UV resistant. Lightweight, long lasting, 100% recyclable. Fireproof.

For cleaning we recommend using a sponge cloth with soapy water. Abrasives and solvents must be absolutely avoided! It dries very quickly due to their open structure.

100% Translucent polyethylene



PE1t

White



PE2t

Dove colour



PE3t

Graphite

Il polietilene è un materiale plastico molto adatto all'arredo esterno. Ha una superficie particolarmente pratica, lavabile, resistente ai raggi UV e agli agenti atmosferici nel corso del tempo. Ha un'elevata resistenza agli urti, una resistenza eccellente alla corrosione e ai prodotti chimici.

Non è penetrabile da liquidi come acqua, soluzioni saline o alcool.

Non utilizzare acidi ossidanti, quali acido Nitrico, acido solforico o alogeni.

Polyethylene is a plastic material that is perfectly suitable for outdoor furniture. Its surface is particularly practical, washable, UV and weather-resistant over the time.

Not penetrable by liquids such as water, salt solutions or alcohol, this material stands out also for its high-impact resistance and its excellent resistance to corrosion and chemicals.

Do not use oxidising acids, such as nitric acid, sulphuric acid or halogens.

Materials

Eco-resina / Eco-resin



ER1

Sand



ER2

Graphite

Eco-resina è un mix di materiali 100% ecologici che riducono di oltre 2/3 il peso rispetto al tradizionale cemento, conservando la naturalezza e l'aspetto materico dello stesso.

Eco-Resina è una resina acrilica naturale a base d' acqua, non teme il gelo e la lunga esposizione al sole.

Tutti gli articoli trattati con più strati di vernici all'acqua, quindi tutto a basso impatto ambientale.

Pulire con un panno umido senza utilizzare solventi troppo aggressivi.

Eco-resin is a mix of 100% eco-friendly materials. Compared to traditional concrete, they are characterized by a reduced weight by more than 2/3, while preserving the naturalness and the material aspect of the cement.

Eco-Resin is a natural, water-based acrylic resin, resistant to frost and to long exposure to the sun.

All items are treated with several coats of water-based paints, guaranteeing a low environmental impact.

For proper maintenance it is recommended to clean it with a damp cloth avoiding the use of aggressive solvents.

Cemento alleggerito / Lightened concrete



CE1

Sand



CE2

Graphite

Cemento alleggerito fibrorinforzato che lo rende il 30% più leggero rispetto al un classico manufatto in cemento. Le Vernici utilizzate sono specifiche per il cemento con protezione agli agenti atmosferici.

Pulire con un panno umido senza utilizzare solventi troppo aggressivi.

Abrasivi e solventi devono essere assolutamente evitati!

Fiber-reinforced lightweight concrete which makes it 30% lighter than a classic concrete artifact.

The coatings used are specific for concrete with protection against atmospheric agents.

Clean with a damp cloth without using aggressive solvents.

Abrasives and solvents must be absolutely avoided!

Materials

Cemento / Concrete



Beige cement



Grey cement



Blue cement

Il cemento è un materiale naturale e, in quanto tale, durante il suo processo produttivo possono verificarsi leggere sfumature e variazioni delle tonalità dell'impasto cementizio, che caratteristica portante del materiale e della tecnologia.

Le fibre sono una componente dell'impasto cementizio e conferiscono al cemento Ductal la sua estrema resistenza e flessibilità. Se la finitura scelta è molto levigata, le fibre possono intravedersi sulla superficie e devono essere accettate come caratteristica intrinseca alla finitura. I piani in cemento, specialmente di grandi dimensioni, non sono perfettamente planari a causa della natura stessa del materiale e della sua lavorazione artigianale.

Micro cavillature da ritiro, devono essere accettate come fenomeno naturale della lavorazione del materiale.

Piccoli fori e bolle possono apparire sulla superficie dei prodotti in cemento. Essi sono una naturale conseguenza del processo produttivo e parte integrante delle caratteristiche del materiale. Il loro aspetto e la loro quantità varia da finitura a finitura. I fori inferiori a 4 mm di diametro vengono lasciati tali, mentre di norma vengono stuccati quando superano il diametro di 5 mm.

Il cemento è un materiale poroso che tende ad assorbire i liquidi che entrano in contatto con la sua superficie, per questo va protetto con dei prodotti appositi; antidegrado ed antimacchia. È importante quindi evitare il ristagno dei liquidi sui piani e specialmente il contatto prolungato tra cemento e oggetti bagnati quali vasi, bottiglie, bicchieri o teli di plastica: una non corretta evaporazione dei liquidi può causare infatti macchie difficilmente removibili dai manufatti.

Eseguire una pulizia superficiale con l'utilizzo di una soluzione di acqua e detergente neutro con basso contenuto di cera (es. prodotti per pavimenti in marmo). Per macchie insistenti, è possibile utilizzare soluzioni che contengono ammoniaca/candeggina diluita al 10%, cioè 1 parte di candeggina su 10 parti di acqua.

Cement is a natural material and due to its nature it may present slight nuances and variations in its combination, which is a key characteristic of the material and production technology.

Fibres are a component of the cement mix and give the Ductal cement its extreme strength and flexibility.

If the chosen finish is highly polished, fibres may be visible on the surface and must be accepted as an intrinsic feature of the finish.

Cement top and flat surfaces, especially the large ones, are not perfectly flat due to the nature of the material and its craftsmanship.

Micro shrinkage cracks must be accepted as a natural phenomenon of the material's workmanship.

Small holes and bubbles may appear on the surface of cement products. They are a natural consequence of the production process and an integral part of the material's characteristics.

Their appearance and quantity varies from finish to finish.

Holes smaller than 4 mm in diameter are left as they are, while they are normally grouted when they exceed 5 mm in diameter.

Cement is a porous material that tends to absorb liquids which get in contact with its surface, which is why it must be protected with special products such as anti wear sealant and Anti stain sealant. It is therefore important to avoid the stagnation of liquids on the surfaces and especially the prolonged contact between cement and wet objects such as vases, bottles, glasses or plastic sheets: incorrect evaporation of liquids can cause stains that are difficult to remove.

Clean the surface with water and neutral detergent with a low content of wax (for ex. marble flooring products). Stubborn stains can be cleaned by using a solution containing 10% diluted ammonia/bleach, which is 1 part bleach for 10 parts water.

Materials

Terrazzo



Beige



Grey



Red

Terrazzo o graniglia è un materiale nato grazie al riciclo degli scarti del cemento colorato e alla lavorazione del marmo.

Viene ottenuta da una miscela di cementi fortemente leganti, colorati in pasta con ossidi naturali, e schegge recuperate dalla frantumazione dei più svariati tipi di marmo.

La superficie del Terrazzo viene poi levigata per ottenere una finitura piacevole al tatto e per esaltare la bellezza degli inerti.

Pulizia e manutenzione ordinaria con acqua e sapone neutro. Il sapone naturale pulisce, disinfetta e nutre le graniglie proteggendole allo stesso tempo. NON utilizzare detergenti aggressivi o prodotti acidi/alcalini che comprometterebbero il pavimento calcareo. L'utilizzo, periodico, di cera neutra per marmo nell'acqua ravviva i colori e crea un effetto patina che proteggerà le graniglie.

Terrazzo or Graniglia is a material created by recycling coloured cement waste and marble processing.

It is obtained from a mixture of strongly binding cements, coloured with natural oxides, and splinters recovered from the crushing of various types of marble.

The Terrazzo surface is then polished to obtain a finish that is pleasant to touch and to enhance the beauty of the aggregates.

It can be cleaned with water and neutral soap. Natural soap cleans, disinfects and nourishes the graniglia. DO NOT use aggressive detergents or acid/alkaline products that would compromise the limestone floor. The periodic use of neutral marble wax mixed in some water revives the colours and creates a patina effect that will protect the graniglia.

Materials

Cover



Realizzato con un accoppiato in 3 strati. I due strati esterni sono di propilene ed hanno funzione sia estetica, sia di protezione della membrana interna. La membrana interna è il tessuto tecnico che svolge la maggior parte del lavoro e che ha le proprietà di permeabilità all'aria e impermeabilità. Lavaggio: acqua e sapone, no lavaggio a macchina o a secco.

- Composizione tessuto: polipropilene
- Peso del tessuto: gr 170 circa
- Resistenza alla lacerazione (chiodo):
N(MD) 180 - norma EN12310-1
- Resistenza alla penetrazione d'acqua:
mm 1200 - norma EN 1928
- Permeabilità all'aria I/(mq-s):
norma EDANA 140.2-99
- Trasmissione del vapore acqueo: Sd value m 0,051 - norma EN 12752.
- Protezione contro i raggi UV 500/1000 ore

It is made of three coupled layers. The external ones are made of propylene whose function is not only the aesthetic one, since it also protects the internal membrane. Such membrane is the technical fabric that plays the most important role: the permeability to air and the impermeability. Washing: to wash with soap and water, do not wash in washing machine or dry cleaning.

- Composition of the fabric: propylene
- Weight of the fabric: about gr 170
- Resistance to laceration (nail):
N(MD) 180 - EN12310-1 Standard
- Resistant to water penetration:
mm 1200 - EN 1928 Standard
- Resistance to air penetration I/(mq-s):
EDANA 140.2-99 Standard
- Water vapor transmission: Sd value m 0,051 - regulation EN 12752.
- protection against UV 500/1000 hours

Technical information

Legenda / Legend

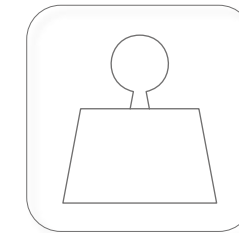

Peso netto KG
Net weight KG

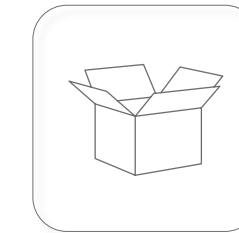

Unità per imballo
Unit for box

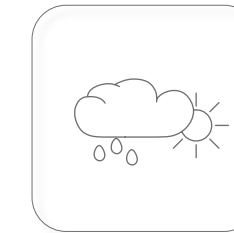

Resistente alle intemperie
Weather-resistant

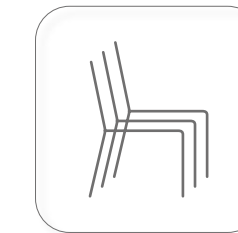

Impilabile
Stackable

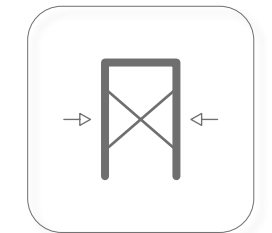

Pieghevole
Folding

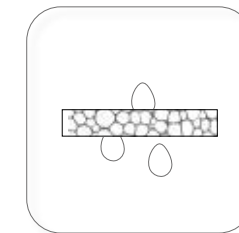

Imbottitura in dry foam
Quick dry foam padding

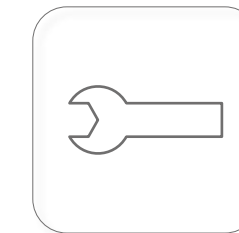

Articolo da assemblare
To assemble

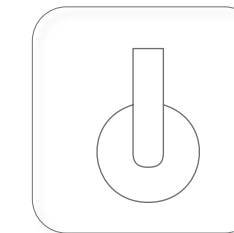

Piedini con ruote
Feet with wheels

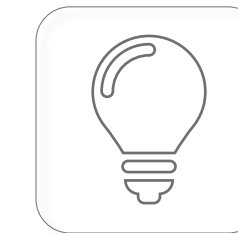

Provisto di illuminazione
With lighting system



Alimentazione a batteria
Battery powered

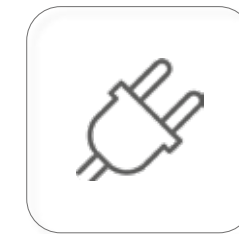

Alimentazione a 220V
220V power supply

Per ogni articolo sono indicate caratteristiche, dimensioni, peso, numero dei pezzi nell'imballo, materiali e colori.

For each item are provided features, sizes, weight, packaging, material, available colours.

CONDIZIONI GENERALI DI VENDITA

1. I colori, disegni e misure dei prodotti presenti nel catalogo sono indicativi. La Talenti Spa ha facoltà di eliminare o modificare i modelli delle proprie collezioni senza alcun preavviso.
2. I prezzi dei modelli standard sono espressi nello specifico listino prezzi fornito dall'azienda. Per quanto riguarda gli articoli su misura il preventivo verrà tempestivamente fornito dalla Talenti dietro richiesta del cliente.
3. L'acquirente è tenuto a controllare sempre la merce e ad indicare nel DDT la data di ricevimento, la persona che la riceve ed il timbro della ditta, nonché le eventuali anomalie nel materiale. Talenti Spa accetterà esclusivamente reclami presentati entro 5 (cinque) giorni dal ricevimento della merce.
4. La Talenti Spa con la consegna al vettore in nessun caso risponde dei rischi a cui la merce è sottoposta durante il trasporto. Quindi eventuali ammanchi, rotture, deterioramenti o manomissioni sono a totale carico dell'acquirente.
5. Gli ordini dovranno essere fatti per scritto utilizzando i codici, descrizioni e prezzo come da catalogo e listini prezzi relativi.
6. Per ogni controversia è competente il foro di Terni (Italia).

GENERAL CONDITIONS OF SALE

1. The colours, drawings and sizes of the products in this catalogue are approximate. Talenti Spa reserves the right to discontinue or change the models in its collections at any time without advance notice.
2. The prices of the standard models are expressed in the specific price list that Talenti Spa will provide. Concerning customized items the offer will be immediately made and provided by Talenti Spa on request of the customer.
3. The purchaser is always required to inspect the goods and indicate on the transport document the date of receipt, the person who received it and the company's stamp, as well as any anomalies found in the material. Talenti Spa will not accept any claims presented more than 5 (five) days after receipt of the goods.
4. Once Talenti Spa has delivered products to the carrier, it is no longer responsible for risks these are subject to during transport. The purchaser is thus totally responsible for any missing pieces, breakage, deterioration or tampering.
5. Orders must be in writing using the codes, descriptions and prices shown in the catalogue and price lists.
6. The Court of Terni (Italy) will be exclusively competent for any disagreements.

INFORMATIVA AI SENSI ART.13 D. Lgs. n. 196/03

“Codice in materia di protezione dei dati personali”
Il trattamento dei dati personali si svolge nel rispetto dei diritti e delle libertà fondamentali, con particolare riferimento alla riservatezza e al diritto alla protezione. Il trattamento viene effettuato per adempiere ad obblighi amministrativo-contabili e fiscali e per l'esecuzione degli obblighi contrattuali. I Vs. dati possono essere comunicati, oltre che a tutti gli incaricati del trattamento all'interno dell'azienda, a consulenti amministrativi, contabili e legali, ad Istituti Bancari.

Titolare del trattamento è TALENTI SPA avente sede legale in Strada Amerina km 4,5, 05022 - Amelia (Tr) - Italy
Al Titolare del trattamento ci si potrà rivolgere per far valere i diritti previsti dall'art. 7 del D.Lgs 196/03.

NOTICE UNDER DL 196/2003, THE PRIVACY LAW

Your personal information will be handled with respect for your rights and fundamental liberties and with particular reference to confidentiality and the right of protection. Your information will be handled to fulfil our administrative, accounting and tax obligations and to fulfil our contractual obligations. In addition to the company's employees assigned to handle your information internally, it may also be communicated to administrative, accounting and legal consultants and to banks.

The owner of the information for handling purposes is Talenti spa, which is located at Strada Amerina km 4,5, 05022 - Amelia (Tr) - Italy
You may contact the owner to assert your rights under article 7 of DL 196/2003.

© 2023/2024 - Talenti spa - Prima edizione
Tutti i diritti riservati - All rights reserved

GRAPHIC DESIGN CONCEPT:
Studio Palomba Serafini Associati
Talenti Technical Department

GRAPHIC DESIGN EDITING:
Talenti Technical Department

PHOTOS:
Giordano Mocchegiani
Giordano Mocchegiani per Rplus
Leonardo Zen
Roberto Sacchini
Gruppo Bento

Karim Rashid by Mario Schmolka
Ramón Esteve by Alfonso Calza

DECOR:
Francesca Conti
Silvia Garattoni
Talenti Technical Department

POST PRODUCTION:
Area 453

SELECTION:
Studio 59

COPYWRITING:
Talenti spa

PRINT:
Varigrafica srl

THANKS TO:
Paola Paronetto
Noleggio Cose
Serax
Cedit-Ceramiche d'Italia (Made in Florim)
Salvadori
Rina Menardi
Kristina Dam Studio
101 Copenhagen
Form and Refine
Agave Fioristi
Sheyn

Talenti spa
Strada Amerina km 4,5
05022 - Amelia (Tr) - Italy
customerservice@talentispa.com
www.talentispa.com