

MFC CUPBOARDS

design office



Specification sheet

CARCASS

Bottom, top and sides made from 18mm easy to clean scratch-resistant anti-reflective melamine faced chipboard (MFC), back panels in 8mm MFC, shelves in 25mm MFC. Panel density: 670/730 kgs per cubic meter.
Optional heavy duty 1.5mm epoxy powder coated steel shelves with lower rails to accept suspended files running front to back.

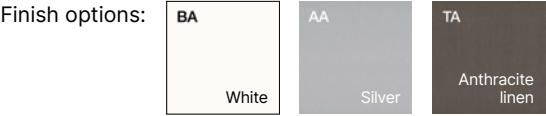

HINGED DOORS IN MELAMINE FACED CHIPBOARD (MFC)

Made from 18mm easy to clean scratch-resistant anti-reflective melamine faced chipboard (MFC) finished with 1mm matching ABS impact resistant edge. Panel density: 670/730 kgs per cubic meter.
Height/width/depth adjustable anti-corrosion treated metal hinges allowing 105° door opening. Lockable doors supplied with two folding keys.

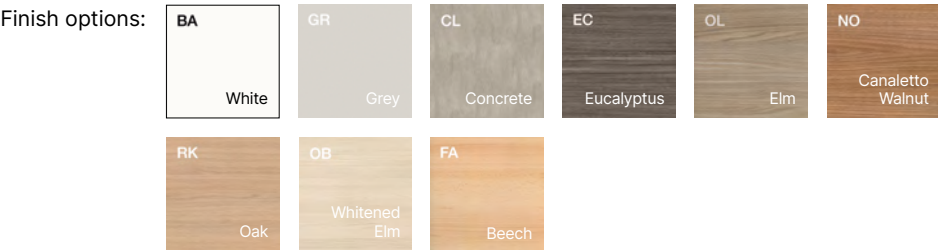

HINGED DOORS IN LACQUERED MELAMINE FACED CHIPBOARD (MFC)

Made from 18mm easy to clean scratch-resistant anti-reflective melamine faced chipboard (MFC) finished with 1mm matching ABS impact resistant edges. The surface is coated using matt lacquers in a variety of colors. Panel density: 670/730 kgs per cubic meter.
Height/width/depth adjustable anti-corrosion treated metal hinges allowing 105° door opening. Lockable doors supplied with two folding keys.



Production lead time: 5 weeks excluding delivery time. Apart from the shown finish options any RAL color can be made to order.

HINGED DOORS IN RECONSTITUTED VENEER

Made from 19mm veneered particle board, 0.6mm wood veneer on both surfaces, finished with 1mm veneer edging, 0.5mm radiused corners. Matt transparent semi-open pore varnish. Panel density: 720/790 kgs per cubic meter. Height/width/depth adjustable anti-corrosion treated metal hinges allowing 105° door opening. Lockable doors supplied with two folding keys.

Finish options:



LEATHER COVERED HINGED DOORS

Made from 18mm melamine faced chipboard (MFC) finished with matching straight melamine edges. Panel density: 670/730 kgs per cubic meter. The door is covered with 1.3mm abrasion resistant leather finished with matching decorative stitching along the perimeter of the panel. Height/width/depth adjustable anti-corrosion treated metal hinges allowing 105° door opening. Lockable doors supplied with two folding keys.

Finish options:

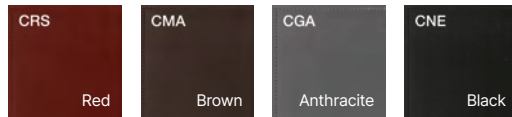

Production lead time: 5 weeks excluding delivery time.

HANDLES FOR MFC HINGED DOORS

Standard ABS handle
Look

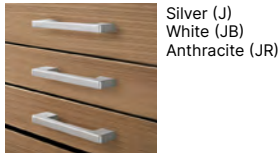

Optional metal handles
Zen

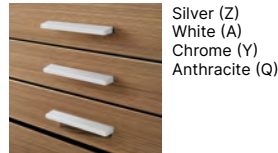

FRAMED GLASS HINGED DOORS

4mm tempered translucent white glass framed hinged doors, 20×19.2mm extruded aluminium frame. Height/width/depth adjustable anti-corrosion treated metal hinges allowing 105° door opening. Lockable doors supplied with two folding keys.

Glass finish options:

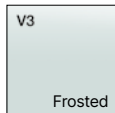

Frame finish options:

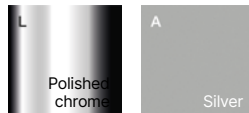

ABS handle



FRAMELESS GLASS HINGED DOORS

4mm tempered translucent smoked glass frameless hinged doors, polished edges and radiused corners. Height/width/depth adjustable anti-corrosion treated metal hinges allowing 105° door opening. Lockable doors supplied with two folding keys.

Glass finish options:

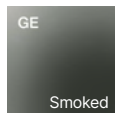

LOW HINGED DOOR CUPBOARD

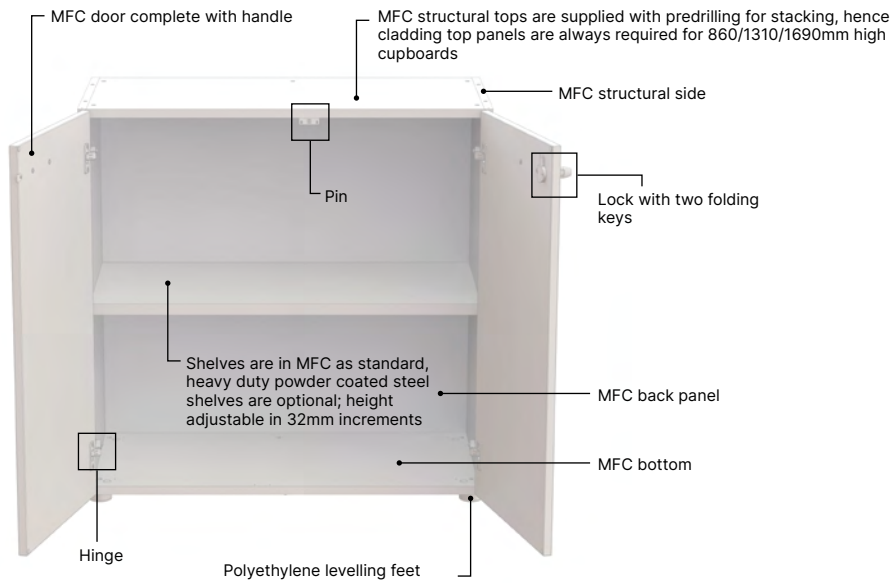

Five ø50mm 27mm high polyethylene feet, 0-15mm adjustable ø25mm levellers.

HIGH CUPBOARD, DOUBLE HINGED DOORS, OPEN SECTION ABOVE

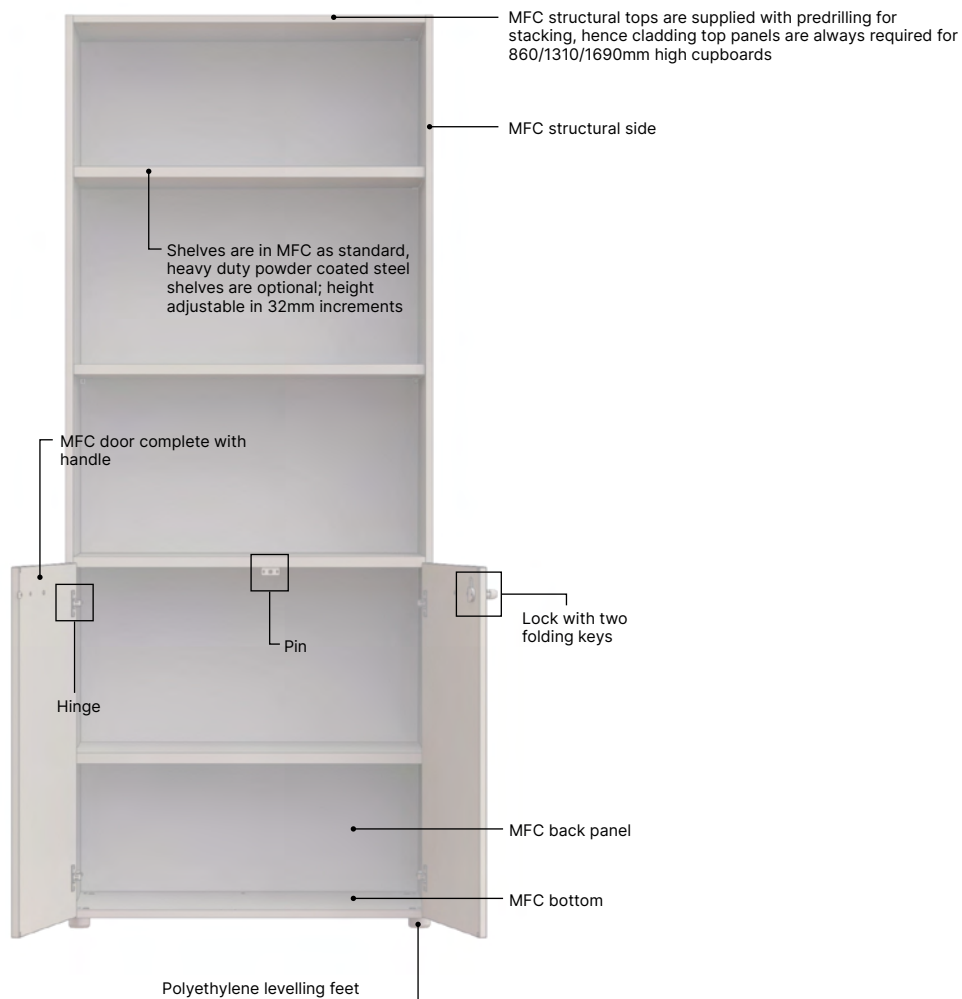

Five ø50mm 27mm high polyethylene feet, 0-15mm adjustable ø25mm levellers.

TWO DRAWER FILING CABINET

Please note: wall anchoring required

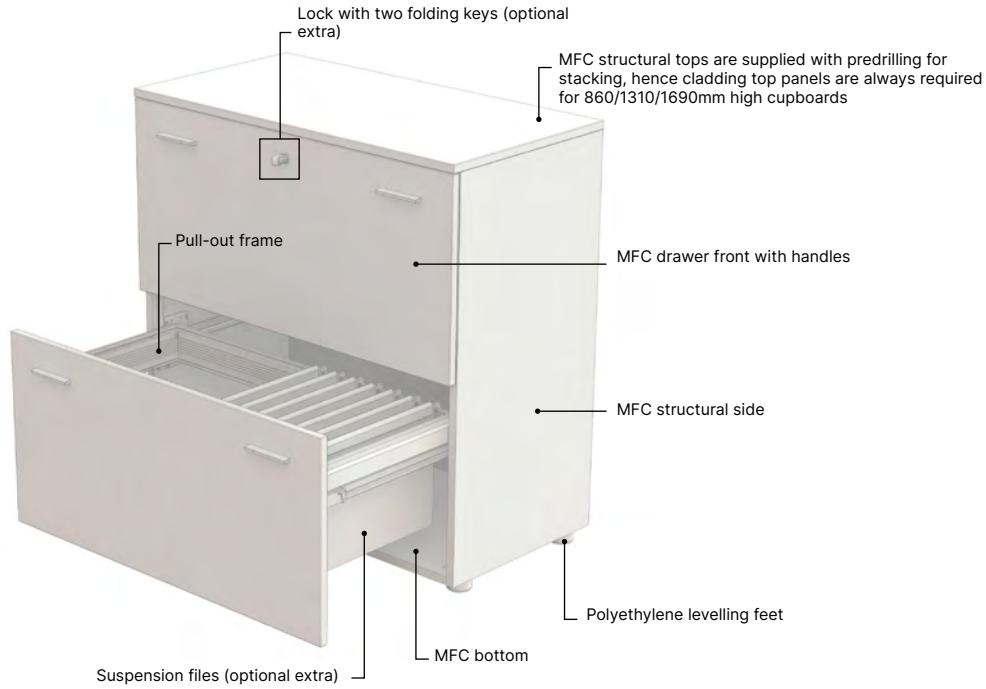

PULL-OUT FRAME FOR 430MM WIDE FILING CABINET

- 1) Suspension files 330mm - A4
- 2) Suspension files 390mm - A4 - foolscap - legal size
- 3) Suspension files letter-size
- 4) Suspension files 330mm - A4 - letter size

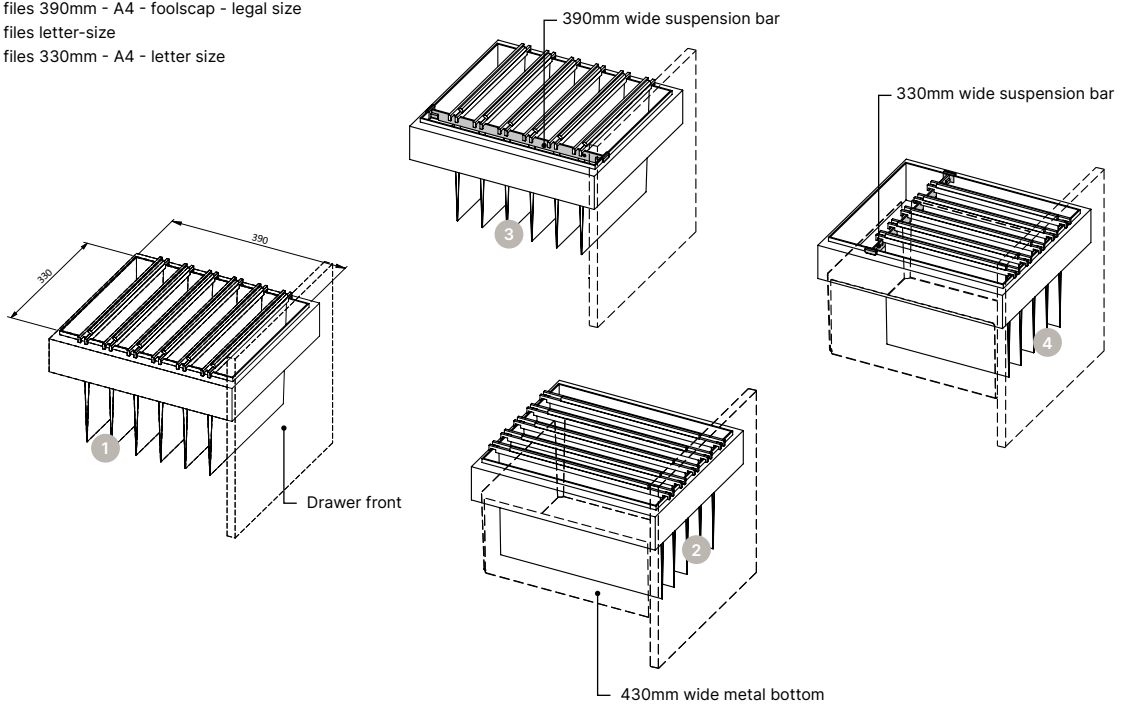

Specification sheet

PULL-OUT FRAME FOR 860MM WIDE FILING CABINET

- 1) Suspension files 390mm - A4 - foolscap - legal size
- 2) Suspension files 330/390mm - A4 - foolscap - legal size - letter size
- 3) Suspension files 330mm - A4 - letter size

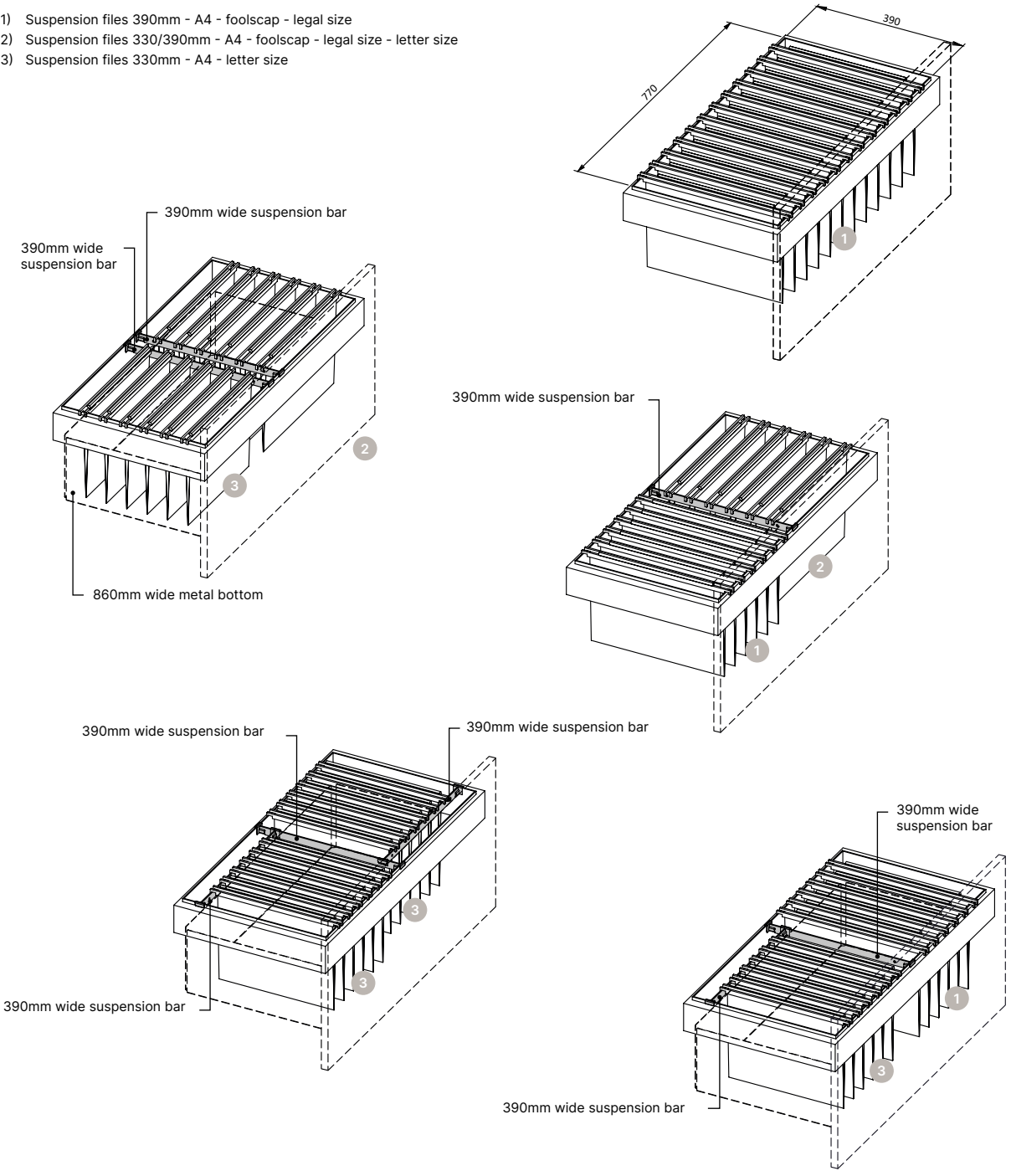

1310MM HIGH HINGED DOOR CUPBOARD

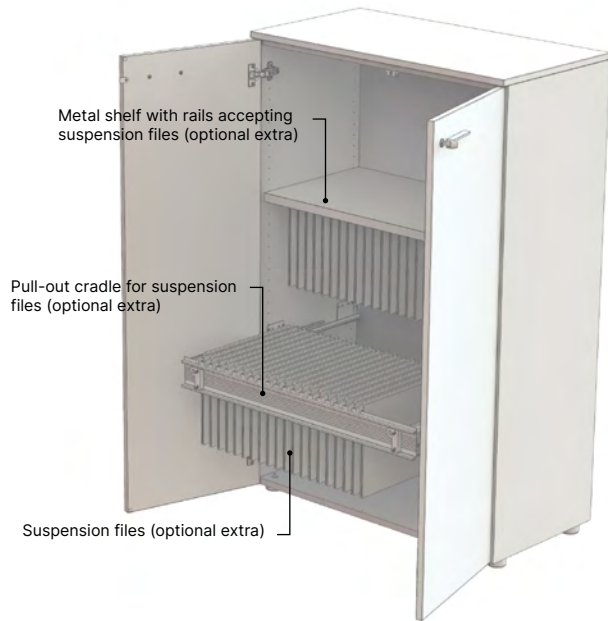

Metal shelf with rails accepting 330mm A4 suspension files (optional extra).



Pull-out cradle for suspension files for 860mm wide cupboards (optional extra)

PULL-OUT CRADLE FOR SUSPENSION FILES FOR 860MM WIDE CUPBOARDS

- 1) Suspension files 330mm - A4 - letter size
- 2) Suspension files 330/390mm - A4 - foolscap - legal size - letter size

Please note: cannot be fitted in sliding door cupboards

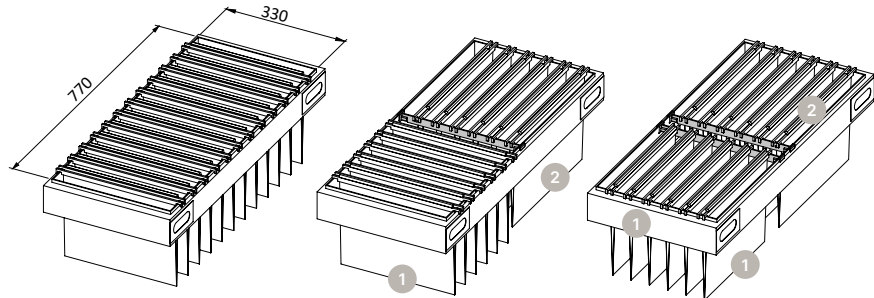

PULL-OUT CRADLE FOR SUSPENSION FILES FOR 860MM WIDE CUPBOARDS

- 1) Suspension files 390mm - A4 - foolscap - legal size
- 2) Suspension files 330/390mm - A4 - foolscap - legal size - letter size
- 3) Suspension files 330mm - A4 - letter size

Please note: cannot be fitted in sliding door cupboards and in hinged door cabinets with multi-point locking rod.

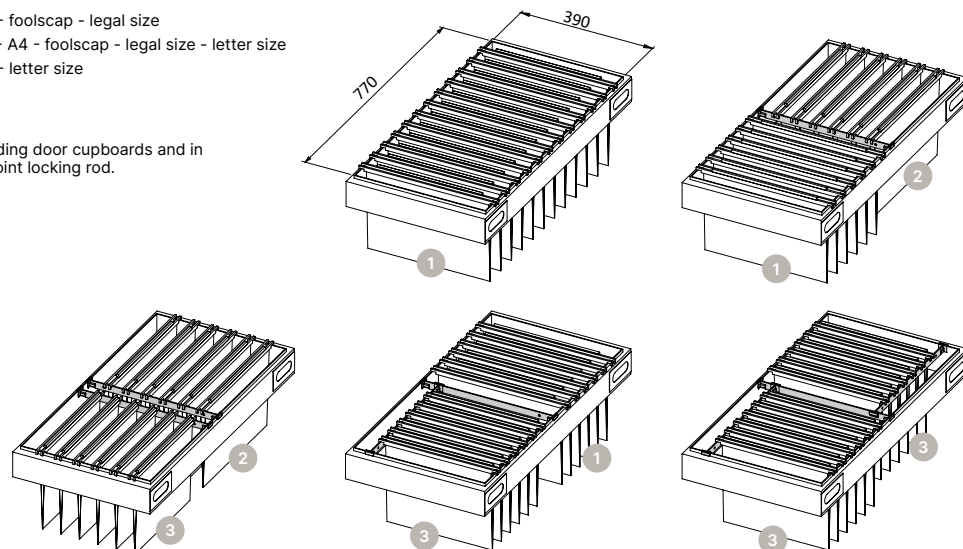

LOW HINGED DOOR CUPBOARD WITH A FRIDGE

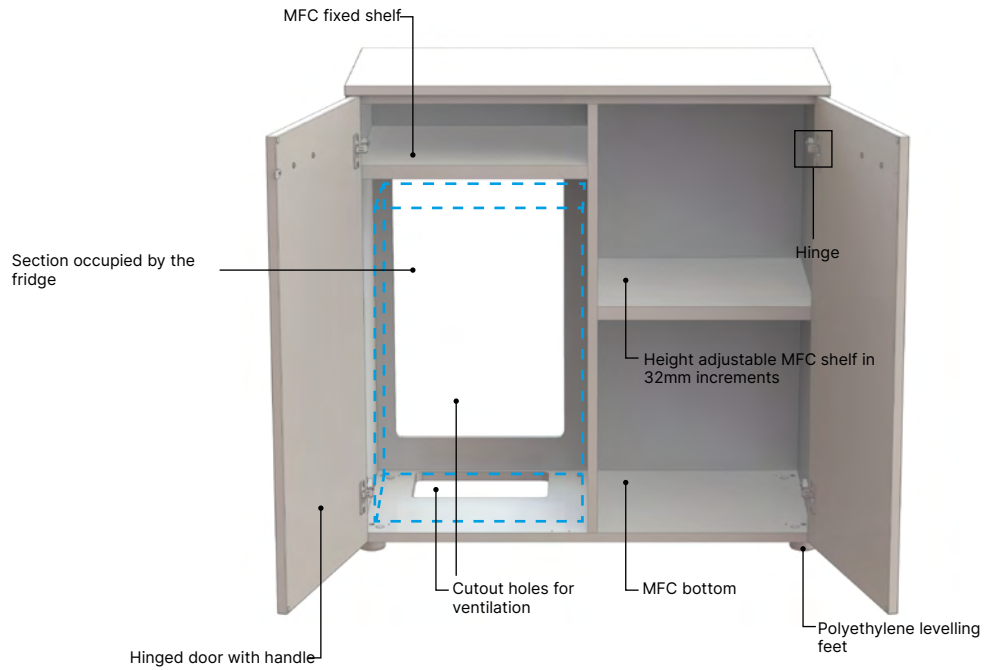

FRIDGE SIZE

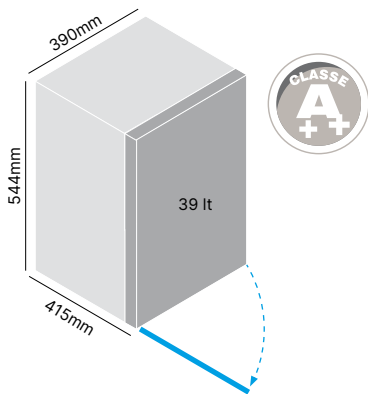

Layout

18/30MM THICK CLADDING TOP PANELS

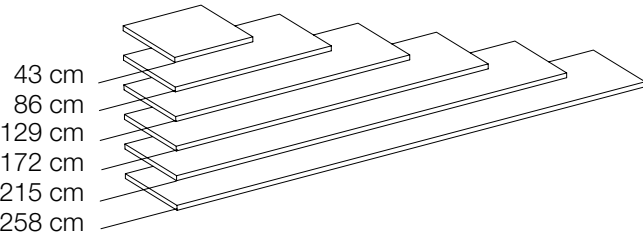

18/30MM THICK CLADDING SIDE PANELS

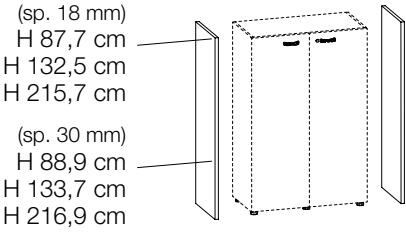

MFC CUPBOARDS (SIZES DO NOT INCLUDE CLADDING TOPS)

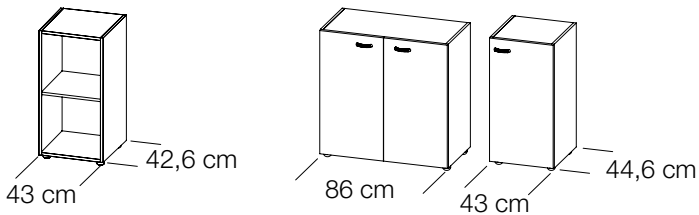
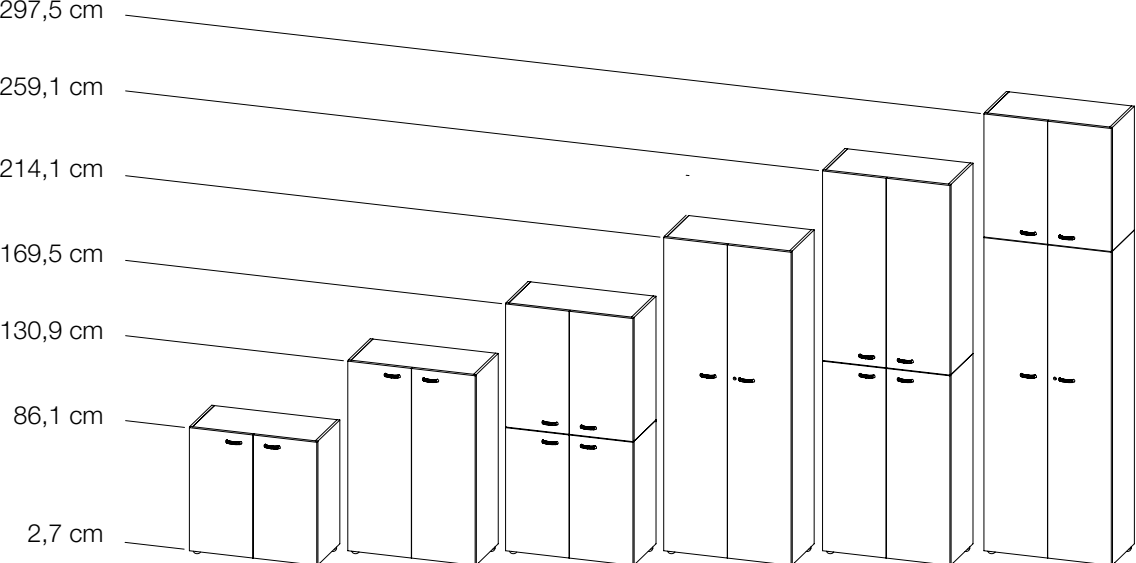

Technical features

MFC CUPBOARDS WITH LEATHER COVERED CLADDING TOP

31.3mm thick leather covered cladding top panel

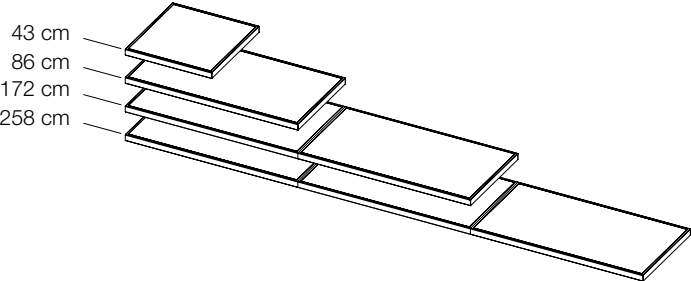

31.3mm thick leather covered cladding side panels

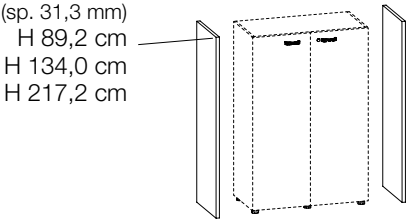

HOW TO ORDER CUPBOARDS WITH LEATHER CLADDING TOPS

- 1) 860mm wide cladding top
- 2) 430mm wide cladding top
- 3) 860mm wide low cupboard with double doors
- 4) 430mm wide low cupboards with door
- 5) 860mm high cladding side

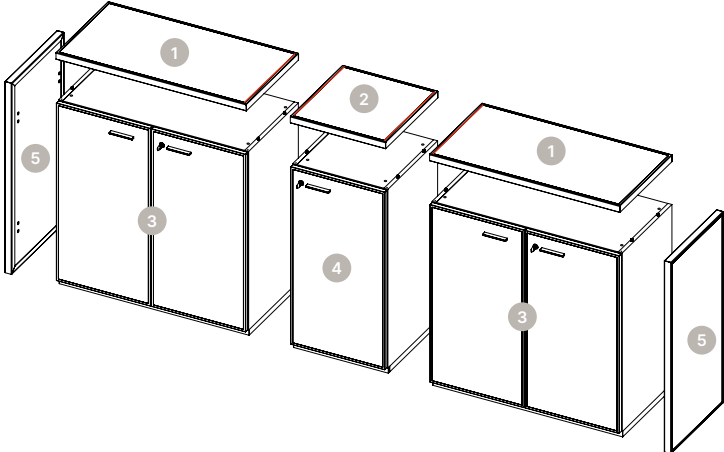
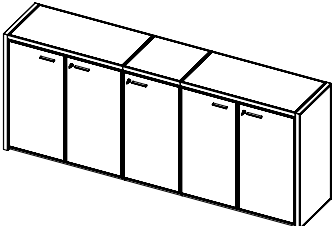

- 1) 860mm wide cladding top
- 2) 430mm wide cladding top
- 3) 860mm wide low cupboard with double doors
- 4) 430mm wide low cupboards with door
- 5) 860mm high cladding side

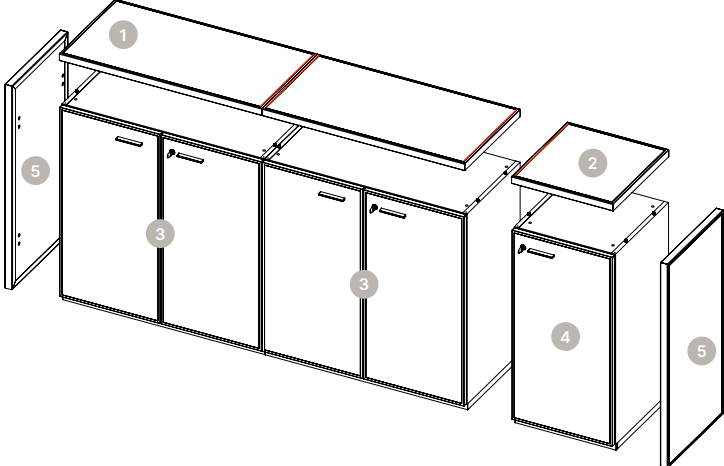
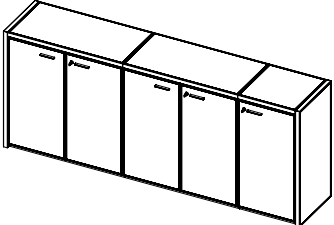

For technical reasons stitching is added:

- every 860mm on 1720mm and 2580mm wide cladding tops
- in the middle (1086mm) on 2172mm high cladding side panels

To clad 1290mm and 2150mm wide credenza units please specify 2no 860mm or 1no 1720mm cladding tops with 1no 430mm.

MFC CUPBOARDS

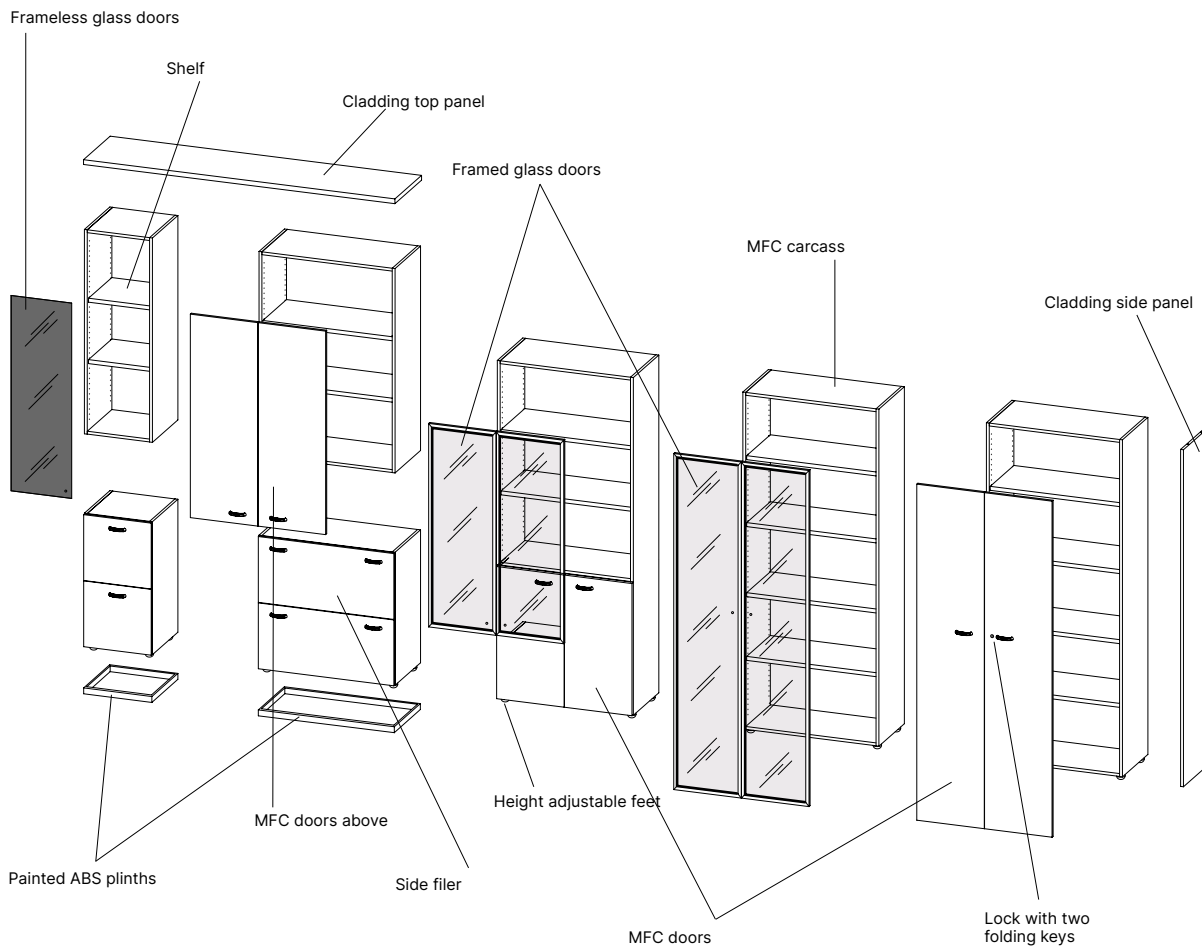

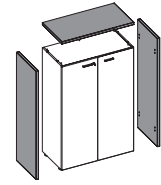

18MM THICK CLADDING TOP AND CLADDING SIDE PANELS

Melamine:

BA White	GR Grey	CL Concrete	EC Eucalyptus	OL Elm	NO Canaletto Walnut
RK Oak	OB Whitened Elm				

Lacquered:

LB White	LL Grey White	LS Silk Grey	NK Light Beige	LE Beige	LT Beige Grey	NU Dark Brown	NW Ocher
LA Orange	NJ Burnt Orange	LH Flame Red	LR Purple Red	LI Black Red	LZ Sapphire Blue	NQ Cobalt Blue	LC Pigeon Blue
LD Ocean Blue	LP Pine Green	NV Olive Green	LF Telegrey 4	LG Grey	LO Urme Grey	LN Traffic Black	

Production lead time: 5 weeks excluding delivery time. Apart from the shown finish options any RAL color can be made to order.

30MM THICK CLADDING TOP AND CLADDING SIDE PANELS

Melamine:

BA White	GR Grey	CL Concrete	EC Eucalyptus	OL Elm	NO Canaletto Walnut
RK Oak	OB Whitened Elm	FA Beech			

Wood veneer:

OG Elm	NA American walnut	EB Ebony
------------------	------------------------------	--------------------

Leather:

CRS Red	CMA Brown	CGA Anthracite	CNE Black
-------------------	---------------------	--------------------------	---------------------



PLANE

24mm high ABS plinth, conceals height adjustable feet



SMART

Rectangular 20x60mm 150mm high metal leg supplied with 0-15mm adjustable ø25mm levellers. Profile and cladding side panels are required.



ROUND

Round ø50mm 150mm high ABS leg supplied with 0-10mm adjustable ø52mm levellers. Profile and cladding side panels are required.



CLASSY

Aluminium 146mm high organic legs, supplied with 0-10mm adjustable ø18mm levellers.



CLASSY+

Aluminium 146mm high organic legs with external decorative profile. Supplied with 0-10mm adjustable ø18mm levellers. Not to be used with storage with cladding side panels.



FAIRY

Aluminium 146mm high organic legs with middle decorative cavity, supplied with 0-10mm adjustable ø18mm levellers.



FAIRY+

Aluminium 146mm high organic legs with middle decorative cavity and external decorative profile. Supplied with 0-10mm adjustable ø18mm levellers. Not to be used with storage with cladding side panels.



25mm high aluminium profile, for using with 150mm high legs and cladding side panels



Pull-out frame



Metal shelf with rails accepting 330mm A4 suspension files



MATERIALS AND RECYCLABILITY

Panels used on Storage range are exclusively 100% made by recycled wood and respect low formaldehyde emission (CATAS certification Quality Award CARB). Resins used on panels and melamine paper are SVHC substances free (reported on ECHA list update to 12/01/2017).



STANDARDS

Storage range has passed the following tests, attested by **CATAS** analysis laboratory in San Giovanni al Natisone (UD).

- General safety requirements EN 14073-2:2004, par. 3.4
- Strength of unit EN 14073-3:2004, clause 5.2
- Strength of top surfaces EN 14073-3:2004, par. 5.4
- Pull out of shelves EN 14073-3:2004, clause 5.3.1
- Strength of shelf supports EN 14073-3:2004, clause 5.3.2
- Horizontal static force on open door EN 14074:2004, clause 6.3.2
- Stability of free standing units EN 14073-3:2004, par. 5.5
- Durability test on hinged and pivoted doors EN 14074:2004, par. 6.3.3
- Vertical load on doors EN 14074:2004, clause 6.3.1
- Deflection of shelves EN 16122:2012 + AC:2015, clause 6.1.4



CERTIFICATIONS

Constantly receptive to market requirements, Quadrifoglio Sistemi d'Arredo pay special attention on quality and safety contents in order to provide high products and services. The Company has reached certifications UNI EN ISO 9001/2015, UNI EN ISO 14001/2015 and UNI EN ISO 45001/2018 to confirm his policy. Our products are certified and ensured by FSC™ and ECOLOGICAL PANEL.

COMPANY WITH
MANAGEMENT SYSTEM
CERTIFIED BY DNV
ISO 9001 • ISO 14001
ISO 45001



GREEN ENERGY

The Company had installed the photovoltaic system with 4.500 solar panels in a 7.350 m² surface that covers almost entirely the factory. The photovoltaic is able to produce 1Mw of a quiet green energy, that does not harm the environment and is waste-free. With his high production capacity the photovoltaic allows us to reduce emissions in the atmosphere of all those polluting substances and to those that contribute to the greenhouse effects. Consequently, such measures make us save every year 180 tonne of petrol oil, 440 tonne of CO₂, 514kg of sulphur dioxide, 448 kg of nitrogen oxide and 23kg of dust.



TRANSPORT

Packaging is reduced in order to decrease volumes. Goods collections are responsibly managed and organised with the aim of optimise transports, reducing atmosphere emissions.