

S·CAB

The image features two modern plastic chairs against a dark green background. The chair on the left is beige, and the one on the right is white. Both chairs have a curved, ergonomic design with a high backrest and armrests. The backrests are composed of several horizontal slats. The legs are thin and slightly tapered. The overall aesthetic is clean and contemporary.

outdoor 2023
easy

85.000 m²

DI PRODUZIONE MADE IN ITALY

Non puoi dire qualità senza usare queste lettere: S•CAB.
Progettiamo e produciamo tutti i nostri prodotti in Italia.
Una garanzia per il cliente di materiali superiori e di una
lavorazione allo stato dell'arte.

TECNOPOLIMERO: DALLA NATURA E DALLA
RICERCA S•CAB
IL MATERIALE D'AVANGUARDIA PER IL COMFORT
ALL'APERTO.

Il tecnopolimero è un composto costituito da materiali
plastici di origine organica e da materiali minerali.
Riceve dai primi la caratteristica di poter essere modellato
sotto l'azione
del calore, ed una eccezionale resistenza agli agenti
atmosferici.
Dai materiali minerali riceve la stabilità, la rigidità,
la notevole robustezza.
La plasticità ha consentito alle avanzate tecniche
di stampaggio Scab di unire alle linee di un design
d'autore tutto il comfort derivato da precisi studi
ergonomici.
Stabilità e consistenza sono espressi in un rapporto ideale
tra peso e robustezza.
L'aggiunta di anti-U.V.A., coloranti e trattamenti
antistatici, garantisce l'aspetto estetico
e l'inalterabilità agli agenti atmosferici
(compresi muffe, smog, polvere).
Infine il coefficiente di conducibilità particolarmente basso
consente ai prodotti Scab di restare a lungo
al sole senza assorbire calore.
Per ridare loro splendore, dopo una stagione
all'aperto, basta un colpo di spugna con acqua e sapone
liquido neutro, evitando i prodotti abrasivi
e a base di cloro ed i solventi.
Il tecnopolimero, grazie alla sua origine naturale,
è un materiale ecologico, riciclabile al 100%.
Tutta la produzione Scab è realizzata solo con
tecnopolimeri di prima qualità.

85,000 SQ. M. OF MADE IN ITALY PRODUCTION

*You really can't say quality without those letters: S•CAB.
We design and produce all our products in Italy.
A guarantee for the customer of first grade materials and state
of the art manufacture.*

**TECHNOPOLYMER: A HIGHLY ADVANCED MATERIAL
PROVIDED BY NATURE AND S•CAB RESEARCH FOR
OUTDOOR COMFORT.**

*The technopolymer is a compound consisting of plastic
materials of organic origin and materials
deriving from minerals. As a result of the first of the two
materials mentioned above,
the technopolymer can be molted under heat and it is
extremely resistant to atmospheric agents.
The materials of mineral origin give the technopolymer its
outstanding characteristics of stability, strength and its
remarkable sturdiness. Due to the plasticity of the material
and the advanced moulding techniques used at Scab, it has
become possible to combine stylish design with all the
comfort deriving from careful ergonomic studies.
Stability and durability are expressed in an ideal ratio between
weight and sturdiness.
The technopolymer is U.V.A. stabilized and with the addition
of colourants and anty-static treatments, its appearance is
guaranteed to remain unaltered, while it is also resistant to
atmospheric agents (including mould, smog and dust).
Lastly, the particularly low coefficient of conductivity means
that Scab products can be left under the sun for long periods
without absorbing heat. To restore the brightness of the
furniture after a season in the open, just wipe with a sponge
using water and neutral liquid soap.
Avoid the use of abrasive products and those containing
chlorine, or solvents.
Thanks to its natural origin, technopolymer is an ecological
material. It can be completely recycled.
The whole Scab production range is made from the finest
quality technopolymer.*

VELA

DESIGN GIANLUCA PASOTTI

EU registered design

Vela è il lettino da sole impilabile che reinventa le regole del relax. Elegante e funzionale ha un design essenziale che lo rende un arredo perfetto per i contesti outdoor, come spiagge e bordo piscina. Ha un telaio in tecnopolimero di ultima generazione arricchito con fibra di vetro e stampato con tecnica air moulding, schienale regolabile, telo reversibile e facilmente ricambiabile, ed è dotato di ruote integrate.

Vela is a stackable sun bed that reinvents the rules for relaxation. Elegant and functional, it has an understated design which means it fits seamlessly into outdoor areas, adorning beaches and pool sides. It has a frame made with the latest generation of technopolymer enriched with glass fibre, with injection moulded using "Air moulding" technology, adjustable back, reversible and quick-change cover, and equipped with wheels.

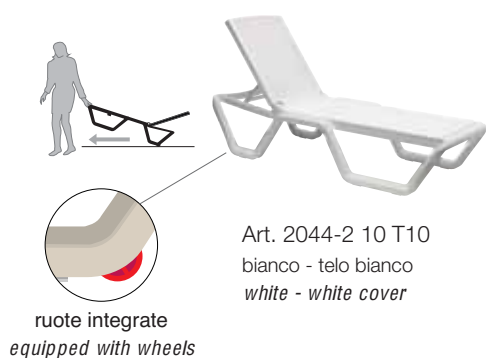

T10
bianco / *white*

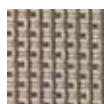

T15
tortora / *dove grey*



T60
blu / *blue*

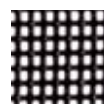

T81
antracite / *anthracite grey*

Il telo facilmente ricambiabile è in tessuto sintetico, traspirante, idrorepellente, indeformabile, resistente ai raggi UV, termosaldato, facile da pulire, lavabile con acqua e sapone.

The quick-change fabric cover is synthetic, breathable, water-repellent, non-deformable, UV-resistant, thermally welded, easy to clean, washable with soap and water.



impilabile - *stackable*



Conforme EN 581-2:2015
Compliant with EN 581-2:2015



2044-2 15 T15
tortora - telo tortora
dove grey - dove grey cover

1897 15
tavolino - side table
tortora - dove grey

TAHITI

DESIGN CENTRO STILE SCAB

EU registered design

ELEGANZA - SEMPLICITA' - FUNZIONALITA'

Lettino Tahiti è l'ultima generazione del lettino da sole di design.

La struttura è ergonomica, confortevole, maneggevole e resistente, grazie alla tecnologia di stampaggio con iniezione a gas e al tecnopolimero di ultima generazione arricchito con fibra di vetro.

ELEGANCE - SIMPLICITY - FUNCTIONALITY

Lettino Tahiti is the latest generation of the design sun lounger. The structure is ergonomic, comfortable, easy to handle, and sturdy, thanks to the gas injection moulding technology and the latest generation of technopolymer enriched with glass fibre.

2043-2 15 T15
tortora - telo tortora
dove grey - dove grey
cover

2043-2 15 T10
tortora - telo bianco
dove grey - white cover

2043-2 81 T81
antracite - telo antracite
anthracite grey - anthracite grey cover

CATAS

Conforme EN 581-2:2015
Compliant with EN 581-2:2015



schienale regolabile in 5 posizioni
backrest adjustable in 5 positions

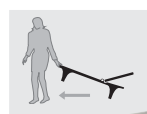

facile da spostare grazie alle ruote integrate
easy to move thanks to the integrated wheels

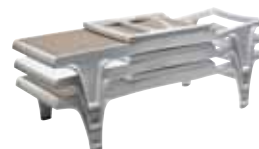

impilabile
stackable



la sostituzione del telo è facile e veloce
the fabric replacement is simple and fast

2043-2 10 T60
bianco - telo blu
white - blue cover

2043-2 10 T15
bianco - telo tortora
white - dove grey cover

2043-2 10 T10
bianco - telo bianco
white - white cover



T10
bianco / *white*

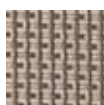

T15
tortora / *dove grey*



T60
blu / *blue*

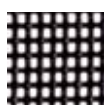

T81
antracite / *anthracite grey*

Il telo è in tessuto sintetico, traspirante, idrorepellente, indeformabile, resistente ai raggi UV, termosaldato, facile da pulire, lavabile con acqua e sapone.

The fabric is synthetic, breathable, water-repellent, non-deformable, UV-resistant, thermally welded, easy to clean, washable with soap and water.

GINEVRA

DESIGN CENTRO STILE SCAB F. B.

Ginevra, con o senza braccioli integrati, regala un comfort d'eccellenza. La struttura in tecnopolimero ne permette l'utilizzo sia in spazi d'incontro e pubblici che nel giardino di casa. Tutti i modelli Ginevra sono impilabili.

Ginevra with or without armrests represents exceptional comfort. The technopolymer frame means it can be used both in public meeting places and in the garden at home. All the Ginevra models can be stacked.



Art. 2333 15
tortora - *dove grey*

Art. 2334 73
terracotta
terracotta

Art. 2333 11
lino - *linen*

Art. 2334 51
verde pistacchio
light green



Art. 2333 81
antracite
anthracite grey

Art. 2334 22
senape
mustard yellow

Art. 2333 62
azzurro - *light blue*

Art. 2334 42
rosso geranio
geranium red

CATAS

Conforme EN 16139:2013
Compliant with EN 16139:2013

SUNSET

DESIGN LUISA BATTAGLIA

Poltrona impilabile ampia e confortevole. Classica ed elegante nella sua silhouette a doghe, è un abbinamento ideale per i nuovi tavoli S•CAB. Struttura in tecnopolimero rinforzato fibra di vetro.

A roomy and comfortable stackable armchair.

With its classic and elegant slatted design, it is a perfect match for all S•CAB new tables.

Technopolymer structure, reinforced with glass fibre.



2329 11
lino - *linen*

2329 15
tortora - *dove grey*

2329 81
antracite - *anthracite grey*



2329 42
rosso geranio - *geranium red*

2329 86
grafite - *graphite*

2329 62
azzurro - *light blue*

CATAS

Conforme EN 16139:2013
Compliant with EN 16139:2013



poltrona / armchair
SUNSET
2329 11



PER 3

ALLUNGABILE DA 170 A 220 CM.

DESIGN CENTRO STILE SCAB

Per3, con piano in tecnopolimero a effetto doghe e gambe in alluminio verniciato, si estende in lunghezza da 170 a 220 cm. con 2 prolunghe per una convivialità da vivere all'aria aperta.

Grazie a volumi equilibrati e forme nette, arreda con moderna eleganza gli ambienti outdoor.

Le prolunghe lo rendono complemento ideale e versatile per tutte le occasioni, formali e informali.

Per3, with a technopolymer slatted top and coated aluminium legs, can be extended in length from 170 to 220 cm. with 2 extensions for dining in the open air.

The balanced size and clean lines of this table bring a touch of modern elegance to outdoor settings.

The extensions makes it very versatile, ideal for all formal and informal occasions.



PER 3
1893 AV 11

ERCOLE 170x100
2145 15

poltrona / *armchair*
SUNSET
2329 15

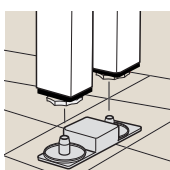

Kit staffe di aggancio
Linking device kit
2942 001

TAVOLO ERCOLE
MISURA 170X100 CM
AFFIANCABILE ALL'INFINITO (DA 170 A 340 CM E SUCCESSIVI MULTIPLI)
E' la componibilità il suo punto di forza.
E' possibile allineare perfettamente più tavoli senza sprechi di spazio
o penalizzazione dei posti a sedere.

ERCOLE TABLE
SIZE: 170X100 CM
ALIGN IT AD INFINITUM (FROM 170 CM, 340, AND MULTIPLE ONES...)
Modularity is its advantage.
*Several tables can be aligned perfectly without wasting space
or sacrificing seating.*



ERCOLE

DESIGN CENTRO STILE SCAB

ERCOLE

Dalla forma elegante, robusta ed essenziale è un richiamo alla storia e al valore delle cose realizzate con qualità.

È un tavolo per esterni realizzato completamente in tecnopolimero con piano a effetto doghe, che arreda ogni ambiente con raffinatezza e sobrietà.

Resistente agli agenti atmosferici è facile da mantenere e da pulire.

Trova in giardini, dehors e bordo piscina la location perfetta per ospitare cene di famiglia o tra amici.

ERCOLE

With an elegant, robust, and essential form, it is a reminder of history and the value of things made with quality.

It is an outdoor table made completely of technopolymer with a parquet-effect tabletop, which furnishes every space with elegance and simplicity.

It is weatherproof and easy to maintain and clean. Found in gardens, terraces, and poolside, it is the perfect location to host family dinners or with friends.



LUCREZIA

DESIGN CENTRO STILE SCAB

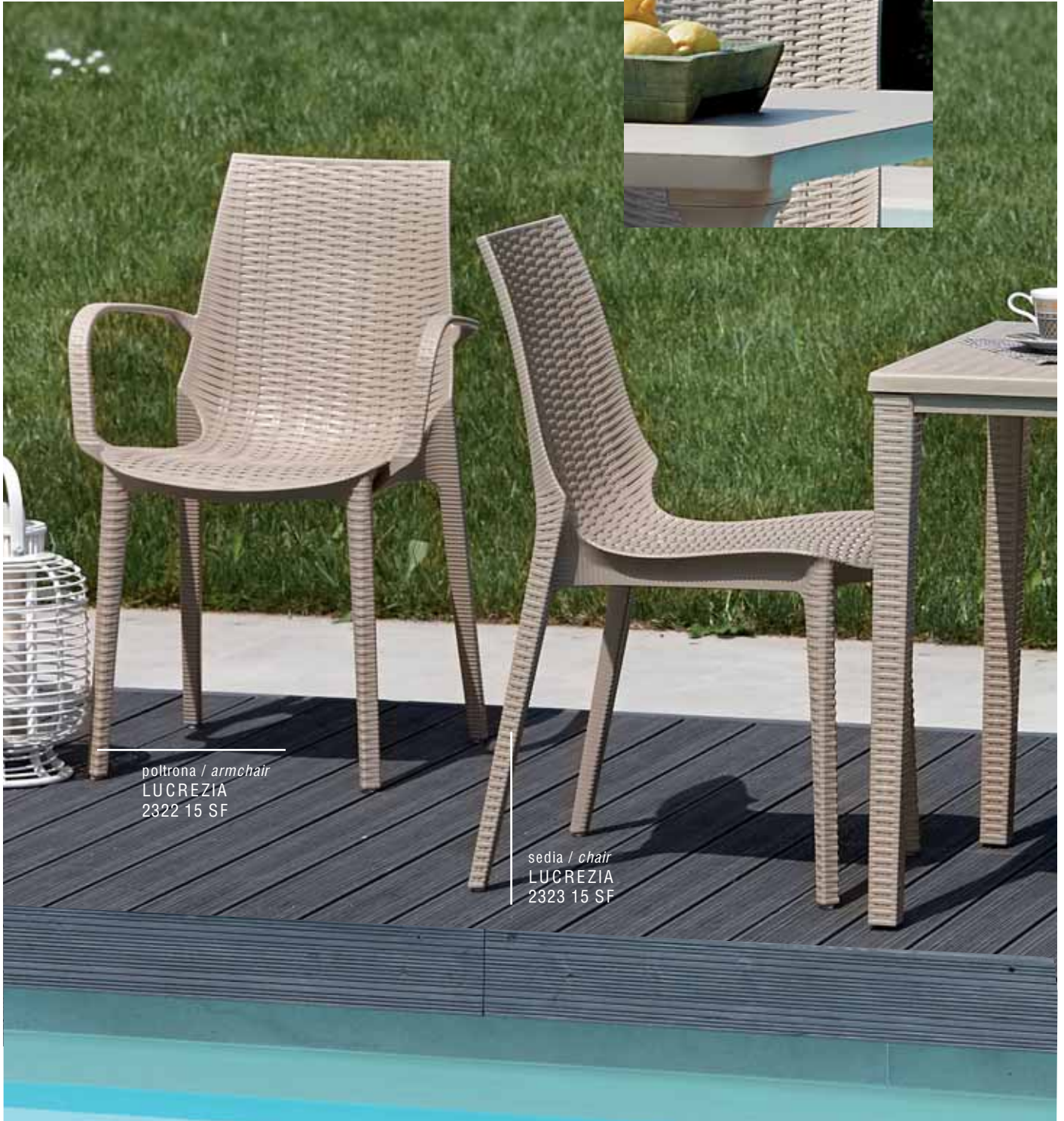

poltrona / armchair
LUCREZIA
2322 15 SF

sedia / chair
LUCREZIA
2323 15 SF

CATAS

Conforme EN 15373:2007
Compliant with EN 15373:2007

POLTRONA INTRECCIATA

TAVOLO INTRECCIATO



tavolo / table
INTRECCIATO 140x80
1047



particolare della
superficie del piano
detail of the table top

poltrona / armchair
INTRECCIATA
1170 SF

TAVOLI SMONTABILI *tables - can be disassembled*

PER 3 TAVOLO ALLUNGABILE
DA CM.170 A 220 CON 2 PROLUNGHE

Piano in tecnopolimero. Gambe quadrate in alluminio verniciato da mm. 70x70.

EXTENDIBLE TABLE FROM 170 TO 220 CM WITH 2 EXTENSIONS

Top in technopolymer. Square 70x70 mm coated aluminium legs.



Art. 1893 AV 11

lino - *linen*



Art. 1893 AV 15

tortora - *dove grey*



Art. 1893 AV 81

antracite - *anthracite grey*

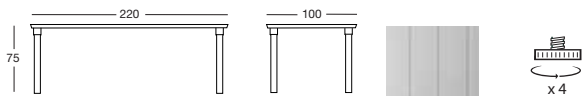

piano a effetto doghe
slatted top

ERCOLE 170x100

Piano e gambe in tecnopolimero, con rinforzi sottopiano in acciaio zincato. Gambe quadrate.

Top and legs in technopolymer, with galvanized steel underlay reinforcements. Square legs.



Art. 2145 11

lino - *linen*



Art. 2145 15

tortora - *dove grey*



Art. 2145 81

antracite - *anthracite grey*

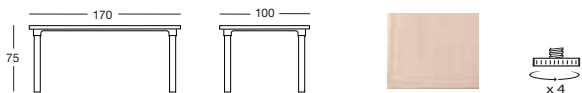

piano a effetto doghe
slatted top

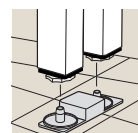

Kit staffe di aggancio
Linking device kit
Art. 2942 001

PRESIDENT 1800



Art. 957

bianco - *white*



RETTANGO Contract



Art. 1067

bianco - *white*

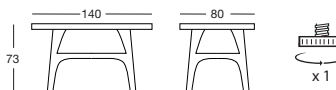

Art. 1061

verde bosco - *forest green*

DADDY Contract 70x70



Art. 963

bianco - *white*

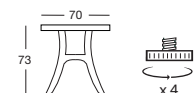

Art. 964

verde bosco - *forest green*

POL ø 70 Contract



Art. 953

verde bosco - *forest green*





particolare della superficie del piano
detail of the table top

PER 3
Con due prolunghe misura
Dimensions
with two extensions
cm. 220x100 h.75

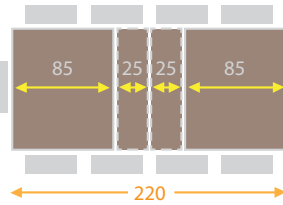

PER 3
Con una prolunga misura
Dimensions
with only an extension
cm. 195x100 h.75

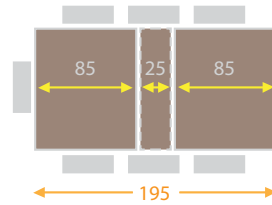

PER 3
Senza prolunghe misura
Dimensions
with any extension
cm. 170x100 h.75

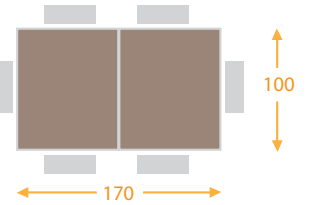

Le prolunghe quando non utilizzate, si ripongono sotto al piano, fissate agli appositi ganci.
The extensions, when not in use, are folded under the surface, fixed to the special hooks.

PRESIDENT TRIS 1700-1950-2200
ALLUNGABILE / extendible



Art. 971
bianco - white

PRESIDENT TRIS
Con due prolunghe misura
Dimensions
with two extensions
cm. 220x95 h.73



PRESIDENT TRIS
Con una prolunga misura
Dimensions
with only an extension
cm. 195x95 h.73



PRESIDENT TRIS
Senza prolunghe misura
Dimensions
with any extension
cm. 170x95 h.73

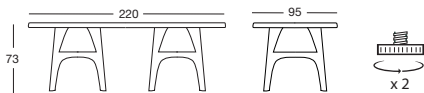

QUADROMAX Contract



Art. 1015
bianco - white



Art. 1012
tortora - dove grey



Art. 1066
verde bosco - forest green

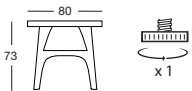

ELLE 80x80



Art. 1033
bianco - white



Art. 1036
tortora - dove grey



Art. 1025
verde bosco - forest green

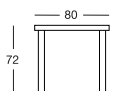

TAVOLI CHIUDIBILI *foldable tables*

RIBALTO 160x90 Contract
piano ribaltabile - *inclining table top*

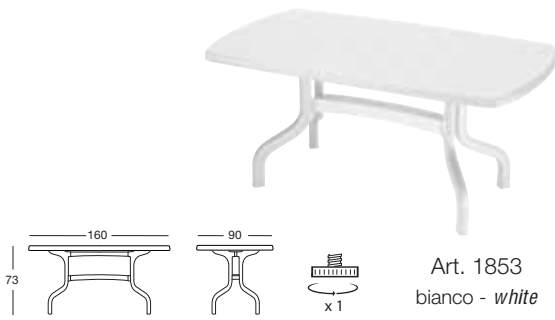

Art. 1853
bianco - *white*

RIBALTO 140x80 Contract
piano ribaltabile - *inclining table top*

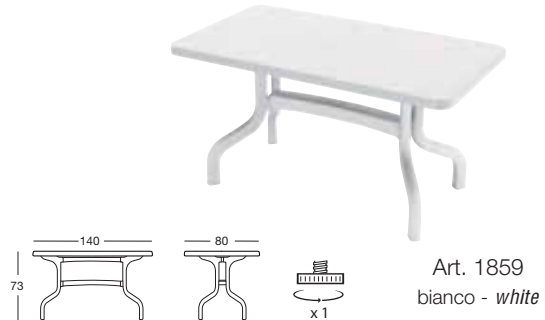

Art. 1859
bianco - *white*

RIBALTO 80x80 Contract
piano ribaltabile - *inclining table top*

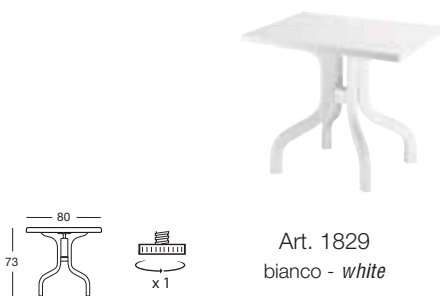

Art. 1829
bianco - *white*

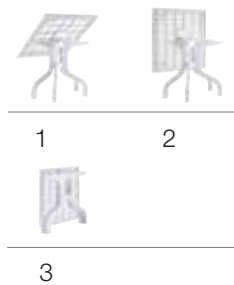

Ribalto, con facilit  si apre e si chiude.

Ribalto si apre e si chiude con pochi semplici movimenti, cos  pu  essere quotidianamente ripiegato e riposto occupando il minimo ingombro.

Versatile: ideale per bar, ristoranti, balconi, terrazzi e giardini.

Ribalto, open and closes with ease.

With just a few simple moves, this table opens and closes so that it can be folded and tucked away on a daily basis thus being of minimum encumbrance.

Versatile: ideal for bars, restaurants, balconies, terraces and gardens.

TAVOLINI *small tables*

VELA
con vassoio amovibile - *with removable tray*



Art. 1897 10
bianco - *white*

Art. 1897 15
tortora - *dove grey*

Art. 1897 81
antracite
anthracite grey

TIP h. 38
smontabile - *can be disassembled*



Art. 1022
bianco - *white*

Art. 1024
tortora - *dove grey*

Art. 1030
verde bosco
forest green

CARRELLO PORTABIBITE *drink trolley*

PERLAGE
chiudibile - *foldable*

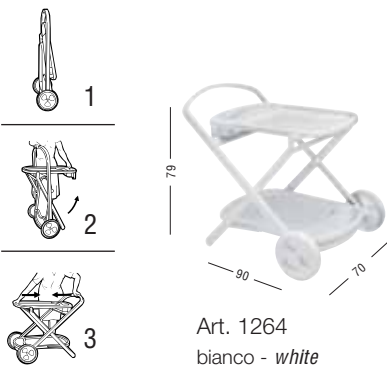

Art. 1264
bianco - *white*

TAVOLI INTRECCIATI *woven patterned tables*

TAVOLO INTRECCIATO 140x80



piano e gambe
in tecnopolimero
effetto intrecciato
*woven patterned
technopolymer
top and legs*



Art. 1047
tortora
dove grey



Art. 1049
antracite
anthracite grey

TAVOLO INTRECCIATO 80x80



piano e gambe
in tecnopolimero
effetto intrecciato
*woven patterned
technopolymer
top and legs*



Art. 1019
tortora
dove grey



Art. 1023
antracite
anthracite grey

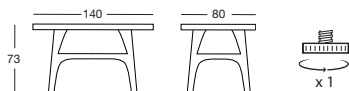

TAVOLO DODO OLIMPO 70x70

piano in tecnopolimero con parabola sottopiano - colonna in alluminio anodizzato - base a quattro piedi in polipropilene e ghisa
technopolymer top with under arch - anodised aluminum column - four feet base in polypropylene and cast iron



piano effetto
intrecciato
*woven patterned
top*



Art. 1898 AA 11
lino - *linen*



Art. 1898 AA 15
tortora - *dove grey*



Art. 1898 AA 70
bronzo - *bronze*



Art. 1898 AA 81
antracite - *anthracite grey*

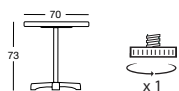

TAVOLINO *small table*

OLLY h.44



piano e gambe
effetto intrecciato
*woven patterned
top and legs*



Art. 2195 81
antracite - *anthracite grey*

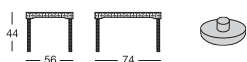

LETTINI DA SOLE *sun beds*

VELA

lettino da sole impilabile con ruote - struttura in tecnopolimero e fibra di vetro - viterie in acciaio inox - regolabile in 5 posizioni
stackable sun bed with wheels - technopolymer and glass fibre frame - stainless steel screws - 5 position adjustable back

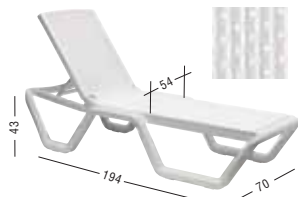

imballo in scatola da 2 pz
packaging in box 2 pcs

Art. 2044-2 10 T10
 bianco - telo bianco
white - white cover



Art. 2044-2 10 T60
 bianco - telo blu
white - blue cover



Art. 2044-2 10 T15
 bianco - telo tortora
white - dove grey cover

imballo su pallet a 16 pz
packaging on pallet 16 pcs

Art. 2044 10 T10
 bianco - telo bianco
white - white cover

Art. 2044 10 T60
 bianco - telo blu
white - blue cover

Art. 2044 10 T15
 bianco - telo tortora
white - dove grey cover

TAHITI

lettino da sole impilabile con ruote - struttura in tecnopolimero e fibra di vetro - viterie in acciaio inox - regolabile in 5 posizioni
stackable sun bed with wheels - technopolymer and glass fibre frame - stainless steel screws - 5 position adjustable back

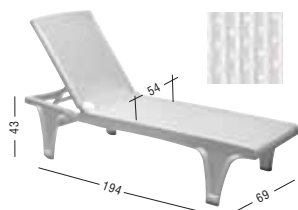

imballo in scatola da 2 pz
packaging in box 2 pcs

Art. 2043-2 10 T10
 bianco - telo bianco
white - white cover



Art. 2043-2 10 T60
 bianco - telo blu
white - blue cover



Art. 2043-2 10 T15
 bianco - telo tortora
white - dove grey cover

imballo su pallet a 16 pz
packaging on pallet 16 pcs

Art. 2043 10 T10
 bianco - telo bianco
white - white cover

Art. 2043 10 T60
 bianco - telo blu
white - blue cover

Art. 2043 10 T15
 bianco - telo tortora
white - dove grey cover

STELLA DI MARE®

lettino da sole con ruote - regolabile in 5 posizioni - chiudibile
sun bed with wheels - 5 position adjustable back - foldable



Art. 1244
 bianco - *white*



Art. 1245
 verde bosco - *forest green*

PIEGHEVOLI *folding, chairs and armchairs*

ESMERALDA LUX 5 posizioni
 poltrona 5 posizioni - chiudibile
5 position armchair - foldable

TESSUTO TRASPIRANTE IDROREPELLENTE
WATER-REPELLENT BREATHABLE FABRIC

ESMERALDA TEX 5 posizioni
 poltrona 5 posizioni - chiudibile
5 position armchair - foldable



Art. 2067 81 T15
 antracite - telo tortora
anthracite grey - dove grey cover



Art. 2067 81 T16
 antracite - telo miele
anthracite grey - honey cover



Art. 2067 10 T10
 bianco - telo bianco
white - white cover

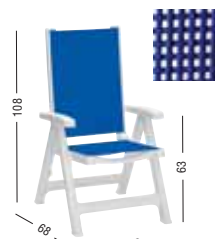

Art. 2073
 bianco - telo blu
white - blue cover



Art. 2070
 bianco - telo bianco
white - white cover



Conforme EN 581-2:2015
Compliant with EN581-2:2015

TELI DI RICAMBIO LETTINI TAHITI E VELA
REPLACEMENT COVER FOR TAHITI AND VELA SUN BEDS
Reversibile e ricambiabile con facilità
Reversible, simple and quick to change



Art. 2044-2 15 T10
tortora - telo bianco
dove grey - white cover

Art. 2044 15 T10
tortora - telo bianco
dove grey - white cover



Art. 2044-2 15 T15
tortora - telo tortora
dove grey - dove grey cover

Art. 2044 15 T15
tortora - telo tortora
dove grey - dove grey cover



Art. 2044-2 81 T81
antracite - telo antracite
anthracite grey - anthracite grey cover

Art. 2044 81 T81
antracite - telo antracite
anthracite grey - anthracite grey cover

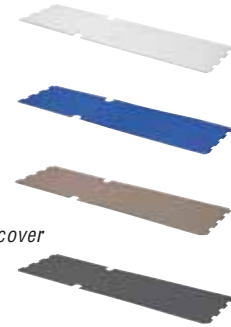

Art. 1521 T10
bianco - *white*

Art. 1521 T60
blu - *blue*

Art. 1521 T15
tortora - *dove grey*

Art. 1521 T81
antracite
anthracite grey



Conforme EN 581-2:2015
Compliant with EN581-2:2015

**TESSUTO TRASPIRANTE
IDROREPELENTE**

Il Tessuto Traspirante Idrorepellente è realizzato con filato di poliestere rivestito da PVC e termosaldato. Questo tessuto offre un'eccezionale resistenza agli agenti atmosferici, è particolarmente adatto all'utilizzo esterno ed è lavabile con acqua e sapone.

**WATER-REPELLENT
BREATHABLE FABRIC**

The water-repellent, breathable fabric has been created using polyester yarn coated in PVC and heat sealed. This fabric offers excellent resistance to atmospheric agents, is particularly suitable for outdoor use and can be washed using soap and water.



Art. 2043-2 15 T10
tortora - telo bianco
dove grey - white cover

Art. 2043 15 T10
tortora - telo bianco
dove grey - white cover



Art. 2043-2 15 T15
tortora - telo tortora
dove grey - dove grey cover

Art. 2043 15 T15
tortora - telo tortora
dove grey - dove grey cover



Art. 2043-2 81 T81
antracite - telo antracite
anthracite grey - anthracite grey cover

Art. 2043 81 T81
antracite - telo antracite
anthracite grey - anthracite grey cover

CASABLANCA

impilabile / *stackable*
lettino da sole con ruote - regolabile in 5 posizioni
sun bed with wheels - 5 position adjustable back



Art. 1255-16
bianco - *white*

CALIFORNIA

lettino da sole con ruote - regolabile in 5 posizioni - chiudibile
sun bed with wheels - 5 position adjustable back - foldable



Art. 1257
bianco - *white*



Art. 1263
tortora - *dove grey*



Art. 1258
verde bosco - *forest green*

CLEOPATRA CON PROLUNGA

poltrona con prolunga
regolabile in 5 posizioni - chiudibile
armchair with extension
5 position adjustable back - foldable



Art. 1124
bianco - *white*

QUINTILLA CON PROLUNGA

poltrona con prolunga
regolabile in 5 posizioni - chiudibile
armchair with extension
5 position adjustable back - foldable



Art. 1138
bianco - *white*



Art. 1139
verde bosco
forest green

CLEOPATRA 5 posizioni

poltrona 5 posizioni
chiudibile
5 position armchair
foldable



Art. 1125
bianco - *white*

QUINTILLA 5 posizioni

poltrona 5 posizioni
chiudibile
5 position armchair
foldable



Art. 1135
bianco - *white*



Art. 1132
verde bosco
forest green

MONOBLOCCO IMPILABILI *stackable monoblocs*

GINEVRA

poltrona impilabile in tecnopolimero rinforzato fibra di vetro - in air moulding
stacking armchair in fibreglass reinforced technopolymer - air moulding technology

CATAS Conforme EN 16139:2013
 Compliant with EN 16139:2013



Art. 2333 11 lino - *linen* Art. 2333 15 tortora - *dove grey* Art. 2333 22 senape - *mustard yellow* Art. 2333 42 rosso geranio - *geranium red* Art. 2333 51 verde pistacchio - *light green* Art. 2333 62 azzurro - *light blue* Art. 2333 73 terracotta - *terracotta* Art. 2333 81 antracite - *anthracite grey*

SUNSET

poltrona impilabile in tecnopolimero rinforzato fibra di vetro - in air moulding
stacking armchair in fibreglass reinforced technopolymer - air moulding technology

CATAS Conforme EN 16139:2013
 Compliant with EN 16139:2013



Art. 2329 11 lino - *linen* Art. 2329 15 tortora - *dove grey* Art. 2329 42 rosso geranio - *geranium red* Art. 2329 62 azzurro - *light blue* Art. 2329 86 grafite - *graphite* Art. 2329 81 antracite - *anthracite grey*

SUPER GIADA



Art. 1235 bianco - *white*



Art. 1236 verde bosco - *forest green*

GIADA



Art. 1111 bianco - *white*



Art. 1114 verde bosco - *forest green*

TIUANA



Art. 1120 bianco - *white*



Art. 1123 tortora - *dove grey*



Art. 1121 verde bosco - *forest green*

SEDUTE *linea intrecciati - woven patterned seats*

OLIMPO SOFA

Scocca intrecciata in tecnopolimero riciclabile rinforzato fibra di vetro. Gambe in alluminio con cover intrecciata in tecnopolimero. Impilabile.
Woven patterned recyclable technopolymer main body reinforced with fibreglass. Aluminium legs with woven pattern technopolymer cover. Stackable.

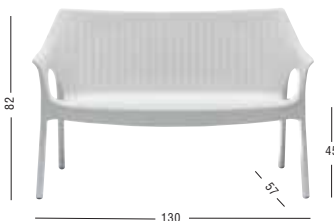

Art. 1252 11 lino - *linen*



Art. 1252 15 tortora - *dove grey*



Art. 1252 70 bronzo - *bronze*



Art. 1252 81 antracite - *anthracite grey*

MAXIMA

CATAS Conforme EN 15373:2007
 Compliant with EN 15373:2007



Art. 2321 70 bronzo - *bronze*



Art. 2321 81 antracite - *anthracite grey*

LUCREZIA POLTRONA

CATAS Conforme EN 15373:2007
 Compliant with EN 15373:2007



Art. 2322 11 SF lino - *linen*



Art. 2322 15 SF tortora - *dove grey*



Art. 2322 70 SF bronzo - *bronze*



Art. 2322 81 SF antracite - *anthracite grey*

GINEVRA

sedia impilabile in tecnopolimero rinforzato fibra di vetro - in air moulding
stacking chair in fibreglass reinforced technopolymer – air moulding technology



Conforme EN 16139:2013
Compliant with EN 16139:2013



Art. 2334 11
lino - *linen*



Art. 2334 15
tortora - *dove grey*



Art. 2334 22
senape
mustard yellow



Art. 2334 42
rosso geranio
geranium red



Art. 2334 51
verde pistacchio
light green



Art. 2334 62
azzurro - *light blue*



Art. 2334 73
terracotta
terracotta



Art. 2334 81
antracite
anthracite grey

STELLA DI MARE®

schienale medio - *medium-sized back*



Art. 1190
bianco - *white*



Art. 1193
verde bosco - *forest green*



Art. 1185
bianco - *white*

SEDIA STELLA DI MARE®

Chair

SUPER ELEGANT

ANTIGRAFFIO *SCRATCHPROOF*



Art. 1900
bianco - *white*



Art. 1903
tortora - *dove grey*



Art. 1901
verde bosco
forest green

CALIFORNIA ③

ANTIGRAFFIO - schienale alto / *SCRATCHPROOF - high-sized back*



Art. 1122
nero - *black*



Art. 1960
bianco - *white*



Art. 1961
verde bosco
forest green

ELEGANT ③

ANTIGRAFFIO - schienale alto / *SCRATCHPROOF - high-sized back*



Art. 1955
bianco - *white*



Art. 1959
tortora - *dove grey*



Art. 1956
verde bosco
forest green

OLIMPIA TREND



Conforme EN 15373:2007
Compliant with EN 15373:2007



Art. 2279 15 SF
tortora - *dove grey*

LUCREZIA



Conforme EN 15373:2007
Compliant with EN 15373:2007



Art. 2323 11 SF
lino - *linen*



Art. 2323 15 SF
tortora - *dove grey*



Art. 2323 70 SF
bronzo - *bronze*



Art. 2323 81 SF
antracite
anthracite grey

POLTRONA INTRECCIATA



Art. 1169 SF
lino - *linen*



Art. 1170 SF
tortora - *dove grey*



Art. 1171 SF
bronzo - *bronze*



Art. 1172 SF
antracite
anthracite grey

Misure e fantasie dei tessuti sono indicative. La S•CAB si riserva il diritto di apportare modifiche o varianti senza preavviso. Tutti i modelli SCAB sono depositati.
The sizes and fabric patterns are given as way of an example. S•CAB reserves the right to make any changes or alterations without prior notice. All the models are registered.



S•CAB sede/*headquarters* - Coccaglio (BS) Italy



S•CAB 3 - Coccaglio (BS) Italy



S•CAB Rudiano (BS) Italy

outdoor

Sede/Headquarters:
25030 Coccaglio (BS) Italia
Via G.Monauni, 32/12
Tel. +39 030 7718.611



Divisione Commerciale Italia:
Tel. +39 030 7718.760/765/770/775
Fax +39 030 7718.777
e-mail: italia@s-cab.it

Export Department:
Phone +39 030 7718.720/725/726
Fax +39 030 7718.700
e-mail: export@s-cab.it

S•CAB si riserva il diritto di modificare, senza preavviso, la propria produzione. Misure e colori sono puramente indicativi. Per ragioni tecniche di stampa i colori/tessuti stampati possono differire lievemente da quelli reali.

S•CAB reserves the right to make alterations to its product range without giving prior notice. Measurements and colours shown are approximatives. The printed colours/fabrics may differ slightly from the actual ones for photo and print technical reasons.

È tassativamente vietato riprodurre senza autorizzazione il materiale fotografico contenuto nel presente catalogo. Ogni modello originale S•CAB è protetto da brevetti di forma e da diritti di esclusiva.
The reproduction of the photographic material contained in the present catalogue is strictly forbidden. All original S•CAB models are covered by shape patents and exclusive rights.

S·CAB

